



Farnell

AN AVNET COMPANY

MANUFACTURING SOLUTIONS

Advancing your facility with industry-leading products

- PLCS
- HDMI
- MOTOR DRIVERS
- SENSORS
- SWITCHES
- TOOLS
- PRODUCTION SUPPLIES

Scan the QR Code to discover us on the web



OUR PEOPLE POWER YOUR SUCCESS

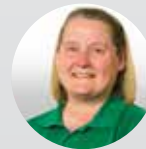

OUR SERVICES



A global electronics distributor that provides you with local support: In person, via phone or online.



Quoting on volume requirements: Dedicated team to assist in quoting you the best possible price.



Not in catalogue sourcing: When product is not available in our range, our team can help you source it directly from the manufacturer.



Parts list upload (BoM manager): Upload your entire parts list or bill of materials with our automated Parts List Upload (BoM) tool.



Product change notification service: Advanced email warning of material change, obsolete, discontinued or end of stock components.



Calibration service: We offer two levels of calibration on new Test & Measurement products bought from us.



Customised enclosures: We offer standard, modification or complete customisation of enclosures to support your design.

YOUR MANUFACTURING PARTNER



Over **80,000 Industrial Automation & Control** products.



42 leading manufacturers including Festo, Schneider, ABB, Omega, Honeywell.



Our new **Industrial Automation & Control Hub** offers dedicated technical resources for IIoT.



Solutions Guides, Whitepapers, Training modules, Podcasts and more.



Over **350k Industrial products** for your end-to-end factory facility needs – Test, Tools, PPE, Chemicals and more.

HELLO AND WELCOME TO OUR MANUFACTURING SOLUTIONS SHOWCASE

At Farnell, we're really excited about Industry 4.0 and the opportunities offered with IIoT to drive efficiencies in manufacturing. Reducing downtime, improving energy efficiency and productivity whilst reducing costs, offer significant benefits for manufacturers. However, the principles of Industry 4.0 can be complex and knowing where and how to begin is challenging.

At Farnell, we are working with some of the biggest suppliers to enable customers of all sizes to take advantage of these concepts and have significantly expanded our range of products to support you in driving greater efficiencies in your manufacturing processes.

Explore our highlights of over **350,000** industrial products online.



Simon Meadmore

VP Product & Supplier Management

TABLE OF CONTENTS

05	INDUSTRIAL AUTOMATION & CONTROL	22	SWITCHES
09	OPTIMISING ENERGY EFFICIENCY	24	TEST & MEASUREMENT
11	FANS & ENCLOSURES	26	TOOLS & PRODUCTION
14	POWER	31	SINGLE BOARD COMPUTERS
18	RELAYS	32	CABLES
20	SENSORS	33	CONNECTORS



Scan the QR Code to
explore IAC online

TECHNICAL RESOURCES CENTRE

Learn innovations,
Stay informed,
Be inspired

A comprehensive selection of products framed into design situations, latest news and trends, design tools and resources to enable you to move from block diagram concept to solution for your vertical segment applications.

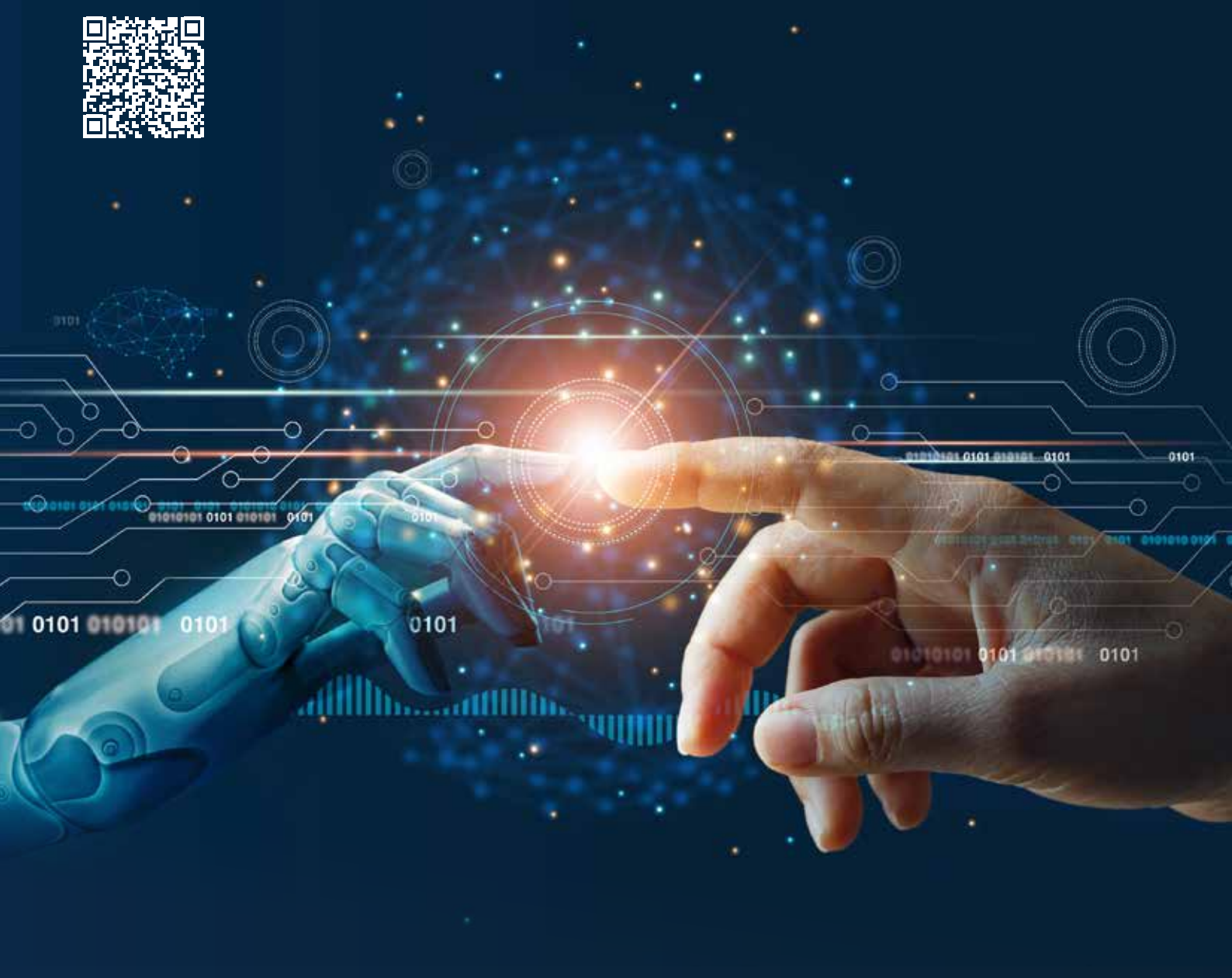

Explore our
expanding library of:



Whitepapers



Articles



How To's



Webinars



Podcast

LED PANEL MOUNT INDICATOR, SATIN CHROME BEZEL, GREEN



The 1904011P is a panel-mount green LED Indicator with satin chrome bezel and maximum 30mA current at 2.2VDC voltage. Due to production tolerances, colour temperature variations may be detected within the individual consignments. The plastic (polycarbonate) is limited resistant against chemicals.



Order Code
1369151

SIGNALLING INDICATOR NEON - RED



The C0180AANAA is a Neon Indicator with 15mm round lens and terminal barrier (6.3 x 0.8mm QC). It comes with a Starlock fixing ring.



Order Code
140006

THE 559 RECTANGLE SERIES SNAP-IN LED INDICATORS



The 559-3501-007F from Dialight is a LED panel-mount indicator. This is a bi-colour, non tinted, diffused LED with 3 leaded wire termination designed for quick positive insertions in panels from 0.787mm through 1.57mm [.062] thick.



Order Code
1138319

SNAP-IN NEON INDICATOR WITH A MODERN STYLE POLYCARBONATE COLOURED ROUND LENS



The C282000NAB is a Neon Indicator with 6.3mm termination tabs and long terminal barrier. Snap-in neon indicator with a modern style polycarbonate coloured round lens (13.6mm). An appropriate resistor is incorporated in the body moulding.



Order Code
147410

CURTIS 700 SERIES IS PCB MOUNTABLE HOUR METER



The CD701-024 is part of the Curtis 700 series is PCB mountable hour meter, it is suitable for OEMs, contract manufacturers, and panel makers for monitoring equipment usage, scheduling maintenance, warranty validation, rental/leasing use and more.



Order Code
516284

DIALIGHT RED PANEL MOUNT INDICATOR



The 559-0103-007F is a 5mm front diffused panel-mount red snap-in LED Indicator for 0.25-inch mounting hole, 12V integral resistor. It is designed for quick positive insertions in panels. The straight 14-inch wire leads terminals are suitable for wire-wrapping.



Order Code
1138325

RED PANEL-MOUNT STANDARD LED INDICATOR



The T000305 is a red panel-mount standard LED Indicator offers prominent-style bezel with flying leads.



Order Code
2472233

LED PANEL INDICATOR 24V 20MA QUICK CONNECT



The 19050351 is a LED Panel Mount Indicator with satin chrome recessed metal bezel, M8 screw thread and 8mm maximum panel thickness. Round-shaped green lens. Brass terminal for anode, tinned terminal for cathode.



Order Code
1105287

NEON INDICATOR AMBER



The C0180AANAB is a Neon Indicator with 15mm round lens and terminal barrier (6.3 x 0.8mm QC). It comes with a Starlock fixing ring.



Order Code
140007

NEON PANEL INDICATOR AMBER QUICK CONNECT



The C027500NAE is a red low profile neon indicator with a nylon body and polycarbonate round-shaped lens. The neon indicator comes with a chrome bezel and fixing nut. An appropriate resistor is incorporated in the body moulding.



Order Code
254915

INDUSTRIAL PANEL MOUNT INDICATORS / SWITCH INDICATORS



The 19010351 is a 24VDC 2-connector panel-mount standard green LED Indicator with satin chrome metal super-flat bezel and M8 screw thread. It has brass anode and tinned cathode terminal pin assignment, Makrolon 2805 plastic construction, diffused lens surface and tab terminals connector.



Order Code
1105266

RED PANEL MOUNT INDICATOR



The 19050353 is a LED Panel Mount Indicator with satin chrome recessed metal bezel, M8 screw thread and 8mm maximum panel thickness. Round-shaped green lens. Brass terminal for anode, tinned terminal for cathode.



Order Code
1105286

LED HOLDER WITH FOCUSING REFLECTOR



The A105000 from Arcoelectric is a LED holder with focusing reflector for use with 5mm, T-1 3/4 LEDs.



Order Code
232312

PANEL-MOUNT GREEN LED INDICATOR



The 19010051 is a panel-mount green LED Indicator with satin chrome bezel and maximum 30mA current at 2.2VDC voltage. Due to production tolerances, colour temperature variations may be detected within the individual consignments.



Order Code
1368960

SNAP-IN NEON INDICATOR WITH A MODERN STYLE POLYCARBONATE COLOURED ROUND LENS



The C282000NAD is a Neon Indicator with 6.3mm termination tabs and long terminal barrier. Snap-in neon indicator with a modern style polycarbonate coloured round lens (13.6mm). An appropriate resistor is incorporated in the body moulding.



Order Code
147411

INDUSTRIAL ETHERNET SWITCHES

multicomp PRO

Plug and play industrial 5 port fast Ethernet network switch with integrated DIN mounting. The high operating temperature range and IP20 rated case makes it ideal for a range of applications.



Order Code
3257512

SWITCH SIZED NEON INDICATOR LIGHTS

multicomp PRO

These snap in, panel mount indicators can be easily fitted next to a switch on a panel to ensure continuity of design. Green, Red and Amber colour options and 13x19mm, 11x30mm or 22x30mm panel cut out sizes.



Order Code
3833948

LIQUID LEVEL CONTROLLERS

OMRON

Fully automatic operation enables both draining and filling simultaneously with a single device. Adjustable sensitivity level from 1k to 200k Ohm, 110VAC, 240VAC & 400VAC supply voltage options.



Order Code
2612083

CONNECTOR END STOP FOR DIN RAIL TERMINAL BLOCKS

WAGO

The 249-117 from Wago is a 10mm wide, grey colour screwless end stop for use with terminal blocks.



Order Code
537895

INDUSTRIAL PANEL MOUNT INDICATORS / SWITCH INDICATORS

Life Is On | **Schneider Electric**

The ZBVB1 is a 24VAC/DC white LED Light Block for Ø22mm pushbutton head.



Order Code
2058818

POE INDUSTRIAL SWITCHES

multicomp PRO

A range of 5 ports 10/100 Fast Ethernet Switches. Send power and data to remote hardware. No software required. Simply plug in and connect.



Order Code
4141429

T120 PANEL INDICATOR LIGHTS

multicomp PRO

250V dome-shaped Neon indicators available in red, green or amber with 10mm, 12mm or 13mm cut-outs.



Order Code
3833959

IPS TFT DISPLAYS - SCREEN SIZES FROM 4.3" TO 15.6"

multicomp PRO

These next-generation of IPS TFT HDMI Displays offer a simple & fast method to integrate a display into your product via an LVDS conversion module on board. Simply connect the display with any single board computer, or computer device with an HD output. Ideal for use with Raspberry Pi, UP or iBASE computers.



Order Code
4067627

SINGLE GANG 47MM DRY LINING BOX

APPLEBY

This SFSB632 dry lining box from Appleby has a large flange around the front that prevents slipping into cavities and matches the profile of the front plate. The box is manufactured from flame retardant thermoplastic and the adjustable tough yellow nylon lugs have large bearing faces for superior strength.



Order Code
3458750

PUN-H SERIES HYDROLYSIS-RESISTANT PLASTIC TUBING

FESTO

Pneumatic Tubing, 2 mm, 1.2 mm, PU (Polyurethane), Red, 6 bar, 50 m.



Order Code
3432486

DIGITAL TIME SWITCHES

GIC

Precise time programming for astro / daily / weekly / pulse switching, 16A single and dual relay outputs, 12/24 hour display format, 6 years battery reserve.



Order Code
1895460

PTC THERMISTOR RELAYS - MP-225

ABB

Uses integrated PTC resistors to monitor and protect Motors against overheating under heavy duty load, high switching frequencies and high operating temperatures & insufficient cooling conditions.



Order Code
3223716

OPEN FRAME TFT DISPLAYS

multicomp PRO

Choice of 7", 10.1", 10.4" and 12.1" active displays within a metal frame that is ideal for use with SBCs, as an HMI or with any device which has an HDMI output. The displays have projected capacitive touch, HDMI interface, automatic dimming and support Rear or VESA mounting enabling easy installation into your equipment.



Order Code
4156127

QUICK MOUNTING END CLAMP

PHENIX CONTACT

End clamp, din rail terminal block, grey.



Order Code
3259549

NPQP SERIES PUSH-IN CONNECTOR

FESTO

Pneumatic Fitting, Push-In Fitting, 10 bar, 6 mm, PP (Polypropylene), NPQP.



Order Code
3431908

MULTI-TUBE HOLDER



Multi-Tube Holder, Pneumatic Cylinder.



Order Code
3439465

NPQP SERIES PUSH-IN CONNECTOR



Pneumatic Fitting, Push-In L-Fitting, R1/4, 10 bar, 8 mm, PP (Polypropylene), NPQP.



Order Code
3431864

PUSH-IN T-FITTING



Pneumatic Fitting, Push-In T-Fitting, R3/8, 10 bar, 10 mm, PP (Polypropylene), NPQP.



Order Code
3431888

QSLV SERIES MULTI-CONNECTOR FITTING



Pneumatic Fitting, Multiple Distributor, R1/4, 14 bar, PBT (Polybutylene Terephthalate), QSLV3.



Order Code
3439283

QSY STANDARD SIZE PUSH-IN Y-CONNECTOR



Pneumatic Fitting, Push-In Y-Fitting, 14 bar, 10 mm, PBT (Polybutylene Terephthalate), QSY.



Order Code
3431820

QSS STANDARD SIZE PUSH-IN BULKHEAD CONNECTOR



Pneumatic Fitting, Push-In Bulkhead Fitting, M12, 14 bar, 4 mm, Brass, QSS.



Order Code
3432103

PNEUMATIC FITTING - REDUCING NIPPLE



Pneumatic Fitting, Reducing Nipple, G3/8, G1/4, 50 bar, Brass, NPFC.



Order Code
3437109

UC PE 10BAR PNEUMATIC SILENCER



Pneumatic muffler, 10 bar, G1/4.



Order Code
3432467

PNEUMATIC REGULATOR



Pressure regulator, 14 bar, G1/4, 1700lpm.



Order Code
3437072

DOUBLE ACTING COMPACT AIR CYLINDER BASED ON ISO 21287



Cylinder, DBL acting, 40mm, 10 bar, 40mm.



Order Code
3431268

ONE-WAY FLOW CONTROL VALVE



One-way flow control valves regulate the piston speed of pneumatic drives during the advance and return strokes. This is done through suitable restriction of the flow rate of compressed air in exhaust air or supply air direction.



Order Code
3432612

SHORT-STROKE CYLINDER



Cylinder, DBL acting, 20mm, 10 bar, 20mm.



Order Code
3431111

INDUSTRIAL 5 PORT FAST ETHERNET NETWORK SWITCH



Switch, 5 Ports, Industrial, Unmanaged Fast Ethernet, DIN Rail, RJ45 x 5, 10Mbps, 100Mbps.



Order Code
2723863

DC MOTOR GEARMOTOR 160 RPM 6VDC



Geared DC Motor, 60:1, 6 V, 213 rpm, 60 mN-m.



Order Code
3498735

CONTACT BLOCK WITH SCREW TERMINALS



Contact Block, 1NO, 6 A, 500 V, 1 Pole, M22 Series, Screw.



Order Code
3718347

MARL 113 SERIES PCB MOUNTED LED



The 113-305-01 is a 3mm 1-way PCB Mount LED suitable for a wide range of PCB applications. This nylon66 (A82) housing material offers UL94V-0 flame retardancy and high-impact strength. This material has a melting point of 200 to 220°C and is suitable for use in the majority of automatic soldering processes.



Order Code
9739220

BULGIN LED PANEL MOUNT INDICATORS CHROME ASSEMBLED W/SEALING



The A10480A from Arcoelectric is a LED holder for use with 5mm, T-1 3/4 LEDs.



Order Code
232324

MARL 103 SERIES PCB MOUNTED LED



The 103-314-04 is a 3mm 20mA green right angle PCB Mount LED saves on board space and assembly time. The 103 series diffused LED gives wide viewing angle. It offers reduced power consumption, outstanding reliability and meets industrial requirements.



Order Code
9737308

PCB MOUNT LED- RED



The 103-305-04 is a 3mm 20mA red right angle PCB Mount LED saves on board space and assembly time. The 103 series diffused LED gives a wide viewing angle. It offers reduced power consumption, outstanding reliability and meets industrial requirements. The long lead of a non cropped unit can also be used to help identify the anode.



Order Code
9737286

PCB MOUNT LED - YELLOW



The 103-311-04 is a 3mm PCB Mount LED suits semi-custom PCB designs. This nylon 66 (A82) housing material offers UL94V-0 flame retardancy and high impact strength. This material has a melting point of 200 to 220°C and is suitable for use in the majority of automatic soldering processes.



Order Code
9737294

PANEL MOUNT INDICATOR- NEON INDICATOR



The H0568BYNAA is a Neon Indicator with 9.5mm round 2.3mm deep domed lens and short terminal barrier.



Order Code
8264767

LED LAMP HOLDER SEALED WITH FOCUS REFLECTOR



The A10500A is a 5mm LED Lamp Holder Sealed with focus reflector, Ø8mm panel cutout, 10mm diameter, 17.9mm length, brass holder with a chrome finish.



Order Code
232336

GREEN NEON INDICATOR WITH THREADED BODY FOR PANEL THICKNESSES, FITTED WITH A RESISTOR



The IND515205-240-T/GRN is a 240V Green Neon Indicator with threaded body for panel thicknesses, fitted with a resistor. The indicator with polycarbonate lens/body, chrome bezel, supplied with nut and shake proof washer, PVC stripped red wire termination, top hat transparent amber lens.



Order Code
745182

CIRCUIT BOARD INDICATOR- YELLOW



The 103-311-01 is a 3mm PCB Mount LED suits semi-custom PCB designs. This nylon 66 (A82) housing material offers UL94V-0 flame retardancy and high impact strength. This material has a melting point of 200 to 220°C and is suitable for use in the majority of automatic soldering processes.



Order Code
9738231

LED PANEL MOUNT INDICATOR - GREEN



The T010315 is a green panel-mount standard LED Indicator offers recessed bezel with flying leads.



Order Code
2472251

LED PANEL INDICATOR RED WIRE LEADS



The L024500MAA is a mains voltage rated panel-mount red LED indicator with a resistor and diode. It is a direct fit replacement for standard neon indicators. It is less susceptible to damage, vibration and flicker-free.



Order Code
9630732

PCB MOUNTED 2-WAY RIGHT ANGLE LED LIGHT PIPE



The 515-1061F is a 3mm round Bi-level Optical Light Pipe with standard design intended as a SMT compatible replacement for 553 series circuit board indicators. The light outputs are spaced vertically 0.1-inch from the PCB to the first element and then 0.2-inch between the top and bottom elements.



Order Code
1461585

GREEN NEON INDICATOR. PANEL MOUNTING



The L024500MAC is a mains voltage rated panel-mount green LED indicator with a resistor and diode. It is a direct fit replacement for standard neon indicators. It is less susceptible to damage, vibration and flicker-free.



Order Code
9630759

3MM 1-WAY PCB MOUNT LED



The 113-311-01 is a 3mm 1-way PCB Mount LED suitable for a wide range of PCB applications. This nylon66 (A82) housing material offers UL94V-0 flame retardancy and a high impact strength. This material has a melting point of 200 to 220°C and is suitable for use in the majority of automatic soldering processes.



Order Code
9739238

AMBER PANEL-MOUNT LED INDICATOR WITH CHROME-PLATED BRASS BEZEL AND WIRE LEADS



The L024500MAB is an amber panel-mount LED indicator with chrome-plated brass bezel and wire leads. This mains voltage rated LED indicator is a direct fit replacement for standard neon indicator. It is more robust, less susceptible to damage and vibration and is flicker-free.



Order Code
9630740

HOW TO OPTIMISE ENERGY EFFICIENCY IN FACTORY PRODUCTION SYSTEMS?

Electric motors are the main power units behind almost all automation devices in production plants. Over 40 percent of generated electricity is consumed by industry and two-thirds of energy is used by electric motors. Losses are an inevitable part of running a motor and they directly affect efficiency. Losses are minimised by using higher cutting edge motor designs, proper motor control selection, and considering the torque of the motor in high-precision automated production systems.



Figure 1 describes the main elements in an automated machine or process found in a modern factory. The efficiency of the motors and the whole production process is determined by multiple control layers. The first control layer adjusts the power inverter switching sequence to manage the motor voltage and current and enhance torque production efficiency.

Next is the position and speed controller that operates the machine efficiently. In process equipment, this could be a sequence of speed or position orders to perform an assembly function, whereas, in automation equipment, this could be a sequence of speed or position commands to execute an assembly function.

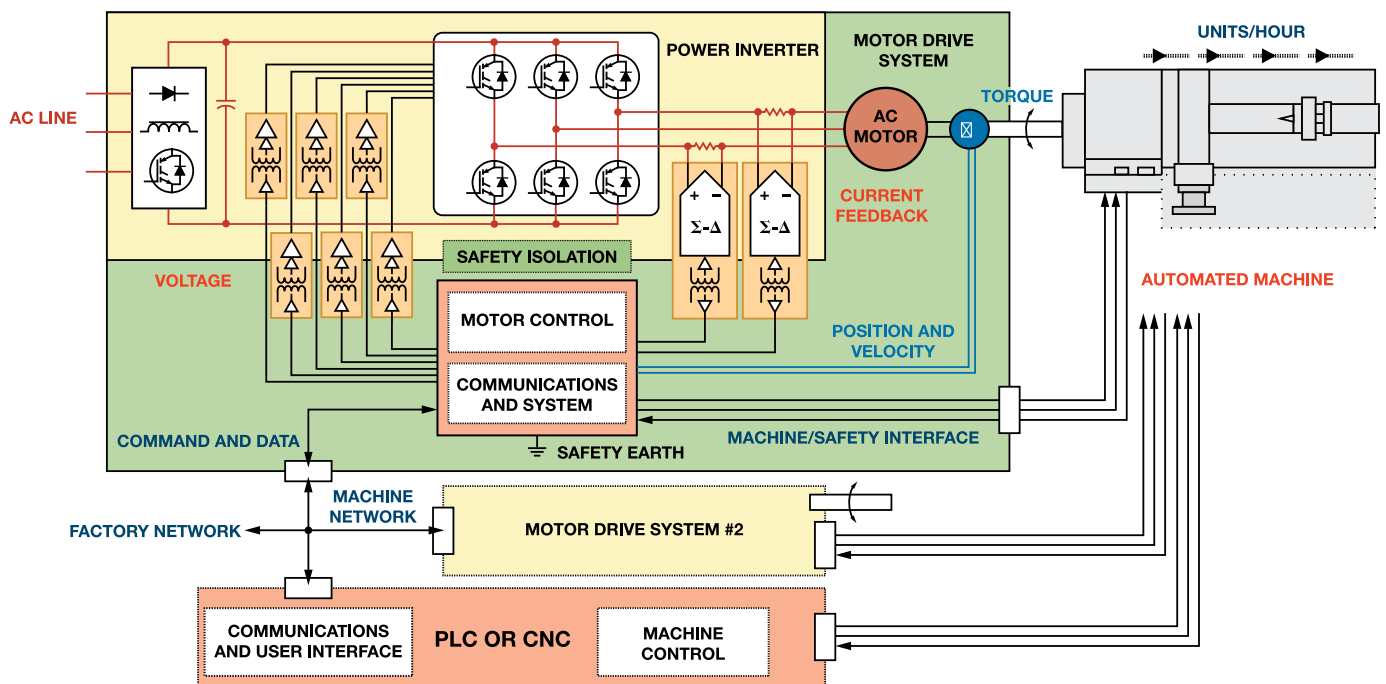

Figure 1: Block diagram of automated machine control system

In the latter scenario, the response time of the speed control will be more critical to the machine controller than torque production efficiency. As multiple motors are now synchronised across high-speed data networks that are also connected to the factory network, the communications and systems layer is becoming increasingly important.

The torque produced per amp supplied at any given speed and terminal voltage influences motor efficiency. Torque is generated by **electric motors** by forces that tend to align their internal magnetic fields. When the stator currents are synchronised with the rotor motion to maintain continuous field misalignment, AC motors produce constant torque. The frequency of the motor currents is closely connected to the ac motor speed, therefore speed regulation necessitates the use of a variable frequency voltage source, such as VSDs or **VFDs**.

When the rotor-stator field misalignment is at its maximum, the efficiency is maximum. Motor efficiency also depends upon motor construction and particularly the rotor field structure. Permanent magnet synchronous motors (PMSM) are more efficient, since no current is required to magnetise the rotor field. Because of their prominent magnetic core construction, ultrahigh efficiency interior permanent magnet (IPM) motors generate additional torque.

Using soft starters in AC induction motors:

When starting, the AC Induction motor develops more torque than is required at full speed. This stress is transferred to the mechanical transmission system, causing excessive wear and premature failure of chains, belts, gears, mechanical seals, and other components. Rapid acceleration also has a significant influence on electricity supply charges, with high inrush currents drawing +600% of the normal run current. The use of Star Delta only provides a partial solution to the problem. If the motor slows down during the transition time, the high peaks will be repeated and may potentially exceed direct on line current. **Soft starters** provide a reliable and economical solution to these issues by delivering a controlled release of power to the motor, resulting in smooth, step-less acceleration and deceleration, as illustrated in Figure 2.

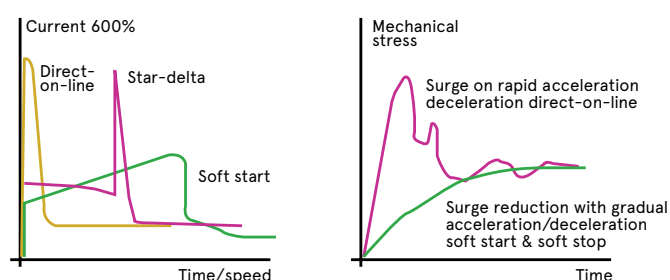

Figure 2: Performance curve as compared to direct-on line, Star-delta and Soft Start

As damage to windings and bearings is reduced, motor life will be extended. Soft Start & Soft Stop is incorporated into three-phase systems, allowing for regulated starting and stopping with a selection of ramp times and current limit settings.

By adopting predictive and condition monitoring:

Condition Monitoring (CM) is the monitoring of several parameters such as equipment vibration and temperature to identify potential concerns such as misalignments or bearing failures. When a vibration analysis reveals a change in the harmonic frequency of rotating equipment components, condition monitoring tools can map equipment degradation.

Frequency analysis can be performed using both vibrometer and microphone data. Continuous Predictive and Condition Monitoring techniques might be used on a range of equipment, including compressors, pumps, spindles, and motors, and they can also be used to detect partial discharge on machines or vacuum leaks. This analysis helps factories to maximise efficiency and equipment availability whilst lowering costs.

Improving efficient motion control with precision isolation and effective communications:

The combination of precision in motion control and communication timing enables shorter machine production cycles and reduces the amount of energy consumed to manufacture each part. PMSM service motors and drives designed for fast response and high precision in speed and position control are used by drive manufacturers to assist automation applications.

The use of high-speed magnetic isolation technology allows for the safe isolation of analog and digital signal voltages without sacrificing speed or precision. Precision **analog-to-digital converters** integrated into the encoder position offer position feedback with up to a 24-bit resolution, enabling high dynamic velocity control at rates as low as 1 RPM.

This level of performance is appropriate for automation applications such as multi-axis milling of precision machine parts, assembly of fine geometry integrated circuits, and injection molding of cell phone parts. Furthermore, to ensure control precision, the motors' motion timing should be perfectly synchronised, because a timing error directly translates into a trajectory error in multi-axis position control.

Industrial Ethernet protocols, such as **PROFINET** and **EtherCat**, use modified Ethernet network interfaces to support real-time data synchronisation with clock jitter as low as 1µs. These network interfaces support both synchronised motion control and factory network connectivity for production system management.

**DC AXIAL FAN, 24 V,
SQUARE, 40 MM, 20 MM,
BALL BEARING, 8.2 CFM**

SANYO DENKI

The 109P0424H602 is a 24VDC 20mm thick Axial Fan with ball bearing and wire leaded power connection. This San Ace 40-series 9P-type fan comes with plastic frame and impeller. UL1007, 24AWG +red and -black lead wire. Clockwise direction of rotation viewed from front of fan blade and continuously run in a free air state.



Order Code
1838827

**DC AXIAL FAN, 24 V,
SQUARE, 40 MM, 20 MM,
SLEEVE BEARING, 5.89 CFM**

ebmpapst

ebm-papst offers a wide range of DC axial fans from 25 mm to 280 mm in size. Many DC fans can be operated on voltages that are up to 50% lower and 25% higher than their nominal voltage (see voltage range in the data sheet).

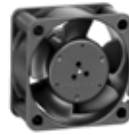

Order Code
9601309

**AC AXIAL FAN, 230V,
SQUARE, 119 MM, 38 MM,
SLEEVE BEARING, 94.17 CFM**

ebmpapst

The renowned ebm-papst range of fans are based on experience gained from decades of development know-how, millions of units in series production, and the innovation competence of a world-wide technology pioneer.



Order Code
9599711

**DC AXIAL FAN, 24 V,
SQUARE, 40 MM, 10 MM,
SLEEVE BEARING, 4.71 CFM**

ebmpapst

ebm-papst offers a wide range of DC axial fans from 25 mm to 280 mm in size. Many DC fans can be operated on voltages that are up to 50% lower and 25% higher than their nominal voltage (see voltage range in the data sheet).



Order Code
9601295

**DC AXIAL FAN, 24 V,
SQUARE, 119 MM, 38 MM,
BALL BEARING, 105.9 CFM**

ebmpapst

ebm-papst offers a wide range of DC axial fans from 25 mm to 280 mm in size. Many DC fans can be operated on voltages that are up to 50% lower and 25% higher than their nominal voltage (see voltage range in the data sheet).



Order Code
1447909

**DC AXIAL FAN, 12 V,
SQUARE, 60 MM, 15 MM,
SINTEC BEARING, 15.9 CFM**

ebmpapst

A range of ebm-papst compact fans aimed at the PC Cooling market. This family of especially quiet cooling fans comes complete with connectors for connection to the motherboard and cover sizes from 40mm to 120mm.



Order Code
1875283

**FAN BLOWER, RLF 35
SERIES, FLATPAK, 24 VDC,
DC, 51 MM, 15 MM, 5.7 CFM**

ebmpapst

The RLF35-8/14N is a 24VDC Centrifugal Compact Fan with ball bearing and wire leaded power connection. Scroll housing of fibreglass-reinforced plastic, fibreglass-reinforced plastic impeller.



Order Code
1293483

**DC AXIAL FAN, 24 V,
SQUARE, 50 MM, 15 MM,
SLEEVE BEARING, 11.8 CFM**

ebmpapst

ebm-papst offers a wide range of DC axial fans from 25 mm to 280 mm in size. Many DC fans can be operated on voltages that are up to 50% lower and 25% higher than their nominal voltage (see voltage range in the data sheet).



Order Code
9600205

**DC AXIAL FAN, 24 V,
SQUARE, 60 MM, 25 MM,
SLEEVE BEARING, 33 CFM**

ebmpapst

ebm-papst offers a wide range of DC axial fans from 25 mm to 280 mm in size. Many DC fans can be operated on voltages that are up to 50% lower and 25% higher than their nominal voltage (see voltage range in the data sheet).



Order Code
9600655

**PLASTIC ENCLOSURE,
HANDHELD, NYLON,
266 MM, 105 MM, 85 MM,
IP65**



Pilot 150 type polyamide hand enclosure for automation and control engineering.



Order Code
1799773

**METAL ENCLOSURE,
1455 SERIES, EXTRUDED WITH
METAL END PANELS, SMALL,
EXTRUDED ALUMINIUM**



The 1455 series enclosures from Hammond is extruded aluminium enclosures with metal end plates suitable for electronic instruments and PCB boards. These enclosures are part of electronic equipments used in any industry for hazardous application.



Order Code
4272857

**PLASTIC ENCLOSURE, IK08,
HIGH BASE, MULTIPURPOSE,
POLYCARBONATE, 60 MM,
130 MM, 180 MM, IP66, IP67**



The PC 150/60 HG is a MNX Enclosure made of polycarbonate (PC) with grey cover. This enclosure utilises world-class injection moulding technology. It is designed to house and protect all kinds of electrical and electronic components in the most demanding applications.



Order Code
2473466

**DC AXIAL FAN, BALL,
24CFM, 0.09A, 24V**

NMB

DC Axial Fan, 24 V, Square, 60 mm, 25 mm, Ball Bearing, 24 CFM.



Order Code
3794021

**DC AXIAL FAN, BALL,
8.8CFM, 0.05A, 24V**

NMB

DC Axial Fan, 24 V, Square, 40 mm, 20 mm, Ball Bearing, 8.8 CFM.



Order Code
3794012

**AXIAL FAN, 119MM, 24V,
108.4CFM, 42.5DB**

NMB

DC Axial Fan, 24 V, Square, 119 mm, 38 mm, Ball Bearing, 108.4 CFM.



Order Code
3642832

HEAT SINK, ULTRA-FIN™, 0.04 °C/W, 101.6 MM, 32 MM, 300 MM



Latest generation extrusion technology and increased thermal performance from a lower mass. Optimum performance achieved when force air cooled 0.04°C/W.

Order Code
4106015

HEAT SINK, ULTRA-FIN™, 0.12 °C/W, 101.6 MM, 32 MM, 100 MM

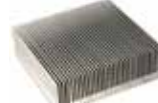

The 890SP-01000-A-100 from H S Marston is a surface-mount high density cooling Ultra-Fin. This Ultra-Fin is developed in extrusion technology allows a much higher fin height to fin spacing ratio.

Order Code
4105977

HEAT SINK, SQUARE, PCB, FOR D PAK, 22.8 °C/W, SO-8, SO-10, SO-14, SO-16, SOT-223, TO-263, 13 MM



The FK 244 13 D2 PAK from Fischer Elektronik is a heatsink for D PAK SMD component. Heatsink dimension is 13mm x 26mm x 10mm (L x W x H).

Order Code
4302436

FAN / FORCE COOLED HEAT SINK, HOLLOW FIN AGGREGATE, 0.085 °C/W, 120 MM, 122 MM, 200 MM



The LA 17/200 24V is a 200mm 230VAC/24VDC fan-cooled Heat Sink with raw degreased aluminium, axial fan, surface mounting, 0.085 to 0.05K/W thermal resistance and without airflow chamber.

Order Code
1222532

METAL ENCLOSURE, EMI/RFI, PCB BOX, STEEL, 16 MM, 30 MM, 55 MM



The PFL2T is a RFI/EMI Enclosure with bright acid tin-plated (good commercial grade) mild steel (BSEN10130DC01) construction. Standard and custom PCB mounting enclosure offers individually and functionality, ideally suited to board level screening applications.

Order Code
1181374

PLASTIC ENCLOSURE, IK08, HIGH BASE, MULTIPURPOSE, POLYCARBONATE, 60 MM, 130 MM, 180 MM, IP66, IP67



The PC 150/60 HG is a MNX Enclosure made of polycarbonate (PC) with grey cover. This enclosure utilises world-class injection moulding technology. It is designed to house and protect all kinds of electrical and electronic components in the most demanding applications.

Order Code
2473466

METAL ENCLOSURE, EMI/RFI, SCREENING CAN, STEEL, 16 MM, 55 MM, 55 MM



The PFL series enclosures from Perancea are PCB mounting frames which are ideally suited for board-level screening application. These PCB frames are used where excellent RFI/EMI attenuation and accessibility is of major concern.

Order Code
1181375

PLASTIC ENCLOSURE, IK08 / IK09, WALL MOUNT, POLYCARBONATE, 130 MM, 190 MM, 190 MM, IP66, IP67



The EKHA 130 T is a Non-metallic Enclosure made of polycarbonate with transparent cover. It features one or more flange openings, permitting modular assembly of multiple units and easy management of wiring with a wide assortment of accessory flange plates.

Order Code
1004105

METAL ENCLOSURE, DIECAST, FLANGED LID, IP54, SMALL, DIECAST ALUMINIUM, 51 MM, 51 MM, 31 MM, IP54



1590 series general purpose, wall-mounting diecast aluminium enclosure with flanged lid and standard version.

Order Code
4437305

PLASTIC ENCLOSURE, FLAME RETARDANT, MULTIPURPOSE, ABS, 25 MM, 56 MM, 85 MM, IP54



The 1591XXMFLGY is a multipurpose Enclosure made of flame retardant ABS plastic with flanged lid. It is ideally suited for horizontally mounting printed circuit boards are designed for vertical board mounting.

Order Code
1877174

PLASTIC ENCLOSURE, DIN RAIL, PLASTIC, 90 MM, 22.5 MM, 82 MM, IP20



Vertical box designed for 5mm pitch plug-in terminal blocks. The plates are to cover unused terminal areas and come in either solid or perforated. Three sides accept 12 way terminal blocks on each side.

Order Code
1774441

PLASTIC ENCLOSURE, WATERTIGHT, MULTIPURPOSE, ABS, 61 MM, 160 MM, 160 MM, IP66



Multipurpose watertight plastic enclosure ideally suited for mounting printed circuit boards or DIN rail mounted components.

Order Code
4081171

AXIAL FAN, 172MM, 230VAC, 212CFM, 56DBA



AC Axial Fan, Rectangular with Rounded Ends, 172 mm, 38 mm, Ball Bearing, 212 CFM.

Order Code
3642846

DC AXIAL FAN, 24 V, SQUARE, 60 MM, 25 MM, SLEEVE BEARING, 27.1 CFM



ebm-papst offers a wide range of DC axial fans from 25 mm to 280 mm in size. Many DC fans can be operated on voltages that are up to 50% lower and 25% higher than their nominal voltage (see voltage range in the data sheet).

Order Code
9600353

AC AXIAL FAN, 230V, SQUARE, 119 MM, 38 MM, BALL BEARING, 94.17 CFM



The renowned ebm-papst range of fans are based on experience gained from decades of development know-how, millions of units in series production, and the innovation competence of a world-wide technology pioneer.

Order Code
9601520



Standard Power Solutions

Modular Power



NMP Series



: The premium series



: The best cost-performance series



Enclosed Type



LRS/SE/RS/
RD/RT/RQ Series



HRP-N3 Series



UHP Series



HEP Series



RSP/RST/SHP Series



DIN Rail Type



MDR Series



HDR Series



SDR/NDR/EDR
WDR//TDR Series



DRS Series



DRC Series



PCB Type



EPS/EPP/
PSC Series



IRM/MPM/
MFM Series

Smart Controller



CMU2 Series

System Power



Dxx-3200 Series



DC/DC Converter



RSD Series



DDR/DDRH Series



NSD/NID Series



Module Type

Green Adaptor



GST/GSM/
GEM/SGA Series



Charger & Inverter



NPB/NPP Series



RPB/RCB Series



ENC Series



GC Series



NTS/NTU Series



LOW PROFILE DIN RAIL MOUNT POWER SUPPLIES

TDK-Lambda

The DSP10-24 from TDK Lambda is a 10.1W low-profile power supply with DIN rail mounting. It complies with UL1310 Class 2(1), UL508 Listed, UL60950-1, EN60950-1, CE safety standards for low profile applications.



Order Code
1456476

320W SINGLE OUTPUT WITH PFC FUNCTION POWER SUPPLY

MW
MEAN WELL

RSP-320-5 is a RSP-320 series 320W single output enclosed type AC/DC power supply. This offers the models with the DC output mostly demanded by the industry. It is cooled by the built-in fan with fan speed control, working for the temperature up to 70°C.



Order Code
2816052

AC/DC ENCLOSED POWER SUPPLY

XP
XP Power

LCW50 series regulated output convection cooled AC to DC power supplies are designed to provide a cost-effective solution for industrial electronics, technology and household applications.



Order Code
3790306

12V AC/DC MEDICAL POWER SUPPLY

TRACO POWER

TPP 300-M series is a set of encapsulated AC/DC power supply in an encased package style. It features a reinforced double I/O isolation (3000VAC) system according to the latest medical safety standards.



Order Code
3931233

MPIF DIN RAIL POWER SUPPLIES

multicomp PRO

IEC/EN/UL approved, high efficiency, high-reliability DIN Rail Mount power supplies with power ratings ranging from 120W to 480W. 3-year warranty guarantee.



Order Code
3872851

480W SINGLE OUTPUT DIN RAIL MOUNT POWER SUPPLIES

TDK-Lambda

The DPP480-24-1 is a 24V/480W 1-output DIN-rail mount Power Supply with wide range AC input, active PFC, parallel function switch, convection cooled, 120 to 140% over-current and 30 to 33V overvoltage protection. This power supply supports global use, easier system configuration and integration.



Order Code
1996013

60W AC-DC RELIABLE GREEN INDUSTRIAL ADAPTOR

MW
MEAN WELL

GST60A series is a highly reliable 30-60W desktop style single output green adaptor. This product is a class I power unit equipped with a standard IEC320-C14 AC inlet and adopting the input range from 90V AC to 264V AC.



Order Code
2815916

160W AC/DC PCB MOUNT POWER SUPPLY

XP
XP Power

ASB160PS24 is a 160W ASB160 series low profile, full brick, baseplate cooled AC to DC power supply which requires no external components. The series includes a complete built in EMC filter and AC fuse as well as bulk storage capacitor providing a complete AC-DC power solution ready for installation into end applications.



Order Code
4145370

48V AC/DC MEDICAL POWER SUPPLY

TRACO POWER

TPI 180-M is a series of encapsulated AC/DC power supplies coming in an encased package. They feature a reinforced double I/O isolation (3000VAC) system can come with the latest industrial standard IEC/ENUL 62368-1. The excellent efficiency allows a high power-density and compact design (3.6" x 2.44").



Order Code
3890295

MPM ENCLOSED AC/DC SWITCHING POWER SUPPLIES

multicomp PRO

IEC/EN/UL approved, cost effective, low no load power consumption, highly efficient, highly reliable enclosed power supplies with excellent EMC performance. Power ratings ranging from 15W to 100W. 3 year warranty guarantee.



Order Code
3974218

15W ULTRA SLIM STEP SHAPE DIN RAIL POWER SUPPLY

MW
MEAN WELL

HDR-15 series economical ultra slim 12-15.4W DIN rail power supply to be installed on TS-35/7.5 or TS-35/15 mounting rails. The body is designed 17.5mm in width which allows space saving inside the cabinets.



Order Code
2815635

ISOLATED SURFACE MOUNT DC/DC CONVERTER

XP
XP Power

IES01 series single output DC-DC power supply ideal solution for isolating voltage rails in a distributed power supply architecture such as analogue, digital, data and relay circuits.



Order Code
3890264

AC/DC DIN RAIL POWER SUPPLY

XP
XP Power

The DRC range of compact lightweight DIN rail mount power supplies are convenient and cost-effective power conversion solution for many industrial and commercial applications.



Order Code
3534640

53V AC/DC INDUSTRIAL POWER SUPPLY

TRACO POWER

TPI 50A-J is a 50W AC/DC open frame power supplies series with a 3000VAC reinforced isolation system. TPI line specifically focuses on providing cost-efficient industrial power supplies in compact designs. This series offers a peak power function which enables the unit to deliver up to 140% of the rated power for up to 5 seconds.



Order Code
3972785

DIN RAIL DC-DC CONVERTERS

multicomp PRO

3:1 & 4:1 Input Range options, internal input filter, Remote ON/OFF, 3 year warranty.



Order Code
3556376

Power supply choice made easy

XP Power are committed to helping customers find the right power solution for any application. Our diverse range of AC & DC products come with reliability designed-in and unrivalled service to match.

Open-frame Power Supplies

- 5W to 450W
- World's smallest designs
- ITE & medical (BF) approvals



Enclosed Power Supplies

- 10W to 5kW
- Full user configurability
- ITE & medical (BF) approvals



External Power Supplies

- 5W to 300W
- Level VI & EU CoC Tier 2
- ITE & medical approvals



DC-DC Converters

- 0.25W to 750W
- Through-hole & SMD
- ITE, medical and rail approvals



High Voltage DC-DC

- Outputs up to 25kVDC
- Regulated & proportional
- Single & dual outputs



XP XP Power

POWERING THE WORLD'S CRITICAL SYSTEMS

TRACO POWER

Reliable. Available. Now.

Industrial Power Solutions

DC/DC from 1–300 Watt

- Broad application range covering office, manufacturing, industrial, harsh and hazardous environments
- Industrial EMC immunity acc. to IEC 61000-6-2
- Various mounting types: PCB, Chassis-Mount and DIN-Rail
- Open-frame, encapsulated and encased package styles
- 3-years warranty

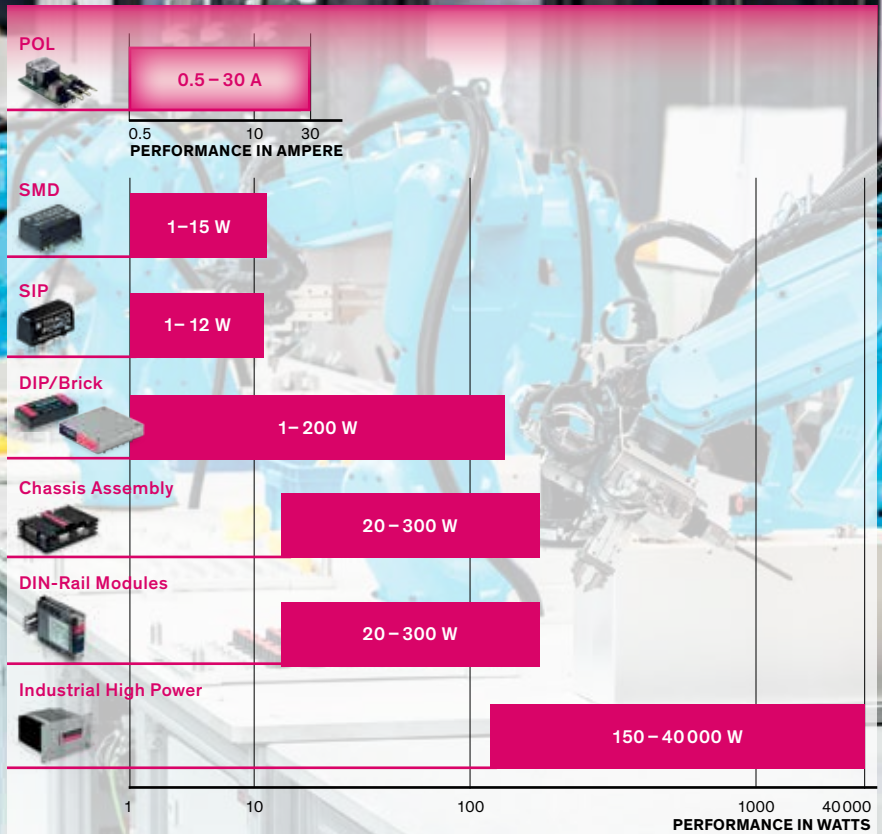

QUINT POWER POWER SUPPLY UNIT – SUPERIOR SYSTEM AVAILABILITY WITH SFB TECHNOLOGY



The QUINT-PS/1AC/24DC/20 is a 1-phase primary-switched Power Supply with SFB technology. Compact power supply units of the new QUINT POWER generation maximise the availability of your system.



Order Code
2068444

QUINT POWER POWER SUPPLY UNIT – SUPERIOR SYSTEM AVAILABILITY WITH SFB TECHNOLOGY



2909577 is a QUINT4-PS/1AC/24DC/3.8/PT primary-switched power supply unit. QUINT POWER provides a superior system availability in the smallest size. Preventative function monitoring and exceptional power reserves are available for applications in the low-power range.



Order Code
4071676

UNINTERRUPTIBLE POWER SUPPLY WITH IQ TECHNOLOGY



The QUINT-UPS 24DC/24DC/20 is an Uninterruptible Power Supply with IQ technology for DIN rail mounting, 24VDC input, 24VDC/20A output, with mounted universal DIN rail adapter UTA 107/30.



Order Code
2068465

8 PIN SIP ISOLATED DC-DC CONVERTER



PQQC3-D48-S5-OS is a PQQC3-OS series is a compact, regulated DC/DC converter providing 3W of output power and a -40 to +85°C temperature range.



Order Code
4128796

U-FRAME ISOLATED DC-DC CONVERTER



PQAE50-D24-S5-U is a PQAE50 series isolated DC-DC converter. It is housed in a compact U-frame package designed for easy installation. It has an operating temperature range of -40 to +105 °C and protection features.



Order Code
4093868

PROECO POWER SUPPLY, SWITCH-MODE POWER SUPPLY UNIT, 24 V



The 1469510000 is a single-phase Switch Mode Power Supply with screw terminal connections (input/output). In the series production of machines, in particular, switch mode power supply unit with above-average performance values can deliver genuine competitive advantages.



Order Code
2723411

2400 WATT FULL BRICK PFC CONVERTER



AC/DC Enclosed Power Supply (PSU), ITE, 1 Outputs, 2.4 kW, 400 VDC, 6 A.



Order Code
3796490

ULTIMOD RANGE OF POWER SUPPLIES



EXCELSYS UltiMod series is unique in flexibility, unrivalled in performance power supply. This a new paradigm, combining technical excellence with logistics simplicity to exceed the most demanding requirements from any industry.



Order Code
3582155

ULTIMOD RANGE OF POWER SUPPLIES



powerMod plug-in module intended for use in Xgen and UltiMod series power supply.



Order Code
3582156

ARTESYN LCC250 AC-DC POWER SUPPLY, 250 WATTS CONVECTION/ CONDUCTION MOUNTING



The LCC250-12U-4P is an AC/DC enclosed Power Supply with adjustable output. Wide operating temperature range suited for outdoor application.



Order Code
2115755

ARTESYN LCM600 SERIES OF 2U HIGH DISTRIBUTED POWER FRONT-END AC-DC POWER SUPPLIES



The LCM600Q-T is an AC/DC enclosed Power Supply with terminal block input. The LCM600 series of 2U high distributed power front-end AC-DC power supply provides a bulk power solution. This model accepts a universal input of 85 to 264VAC and has a typical full load efficiency of 89%.



Order Code
2115741

ISOLATED 1W SINGLE OUTPUT SM DC-DC CONVERTERS



New range of low-cost, lower-profile surface mount DC-DC converters.



Order Code
2518533

3KVAC ISOLATED 1W SM GAN GATE DRIVE DC-DC CONVERTERS



MGN1S0512MC-R7 is a MGN1 series 1W SM GaN gate drive DC-DC converter. It is ideal for powering 'high side' and 'low side' gate drive circuits for GaN in bridge circuits. A choice of output voltages allows optimum drive levels for the best system efficiency.



Order Code
4163285

24V OUTPUT DIN RAIL MOUNT POWER SUPPLY



Compact size, narrow width high-efficiency power supplies.



Order Code
2777430

SINGLE OUTPUT FULL FEATURED DIN RAIL MOUNT POWER SUPPLIES



The DRF480241 is a 24V/480W 1-output DIN-rail mount Power Supply features an ErP compliant design, very compact size, high-efficiency, low standby power draw, remote voltage adjustment and on/off. This power supply output is programmable.



Order Code
2474796

Unlocking the Secrets of Reliable Relays: OMRON's Unique Production Know-How

Creating the perfect relays may seem like a straightforward task, but it's a complex process that requires the most advanced manufacturing processes. This ensures that every component inside our relays are precisely assembled and protected from any outside contaminants. Ignoring this crucial step could jeopardize the reliability of the relays and compromise their switching activity.

At times, machines can experience unplanned downtime, with the causes remaining elusive, in many cases restarting the machine or replacing the relays resolves the issue.

OMRON determined that such incidents are primarily caused by inadequate contact conduction, which frequently results from dust caught between the contacts during manufacturing.

This dust is generated from various sources such as:

- Resin scrap from relay parts
- Textile fibres from operator clothing



OMRON research has revealed that poor conduction of the contacts is the primary cause of relay faults, accounting for approximately 75% of cases.

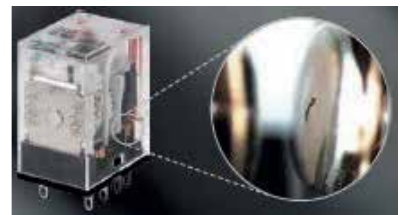

OMRON'S SOLUTION TO PREVENT POOR CONDUCTION IN RELAYS

To improve the reliability of our relay production, OMRON has made three key commitments:

- Provide standardised product design to avoid the generation of dust.
- Produce products in clean rooms with strict entry exit controls to prevent the introduction of dust.
- Utilize OMRON's unique dust removal technology to avoid leaving dust behind during the production process.

With these commitments, OMRON can ensure the highest quality and reliability for your industrial needs.

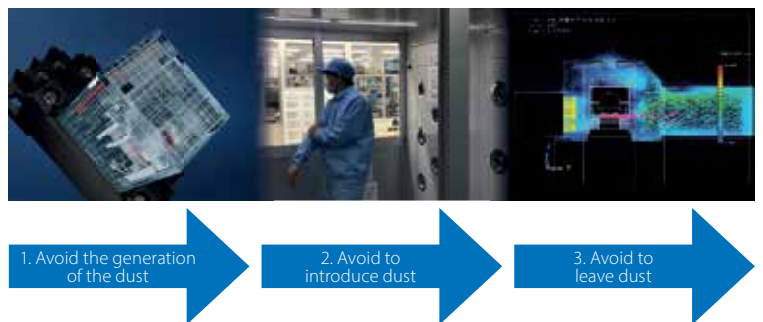

OMRON relays offer supreme quality

For more than half a century, OMRON has dedicated itself to the design and production of relays and has now become the largest manufacturer of single-brand relays worldwide. Among our most significant electromechanical relay families are the G2RS, MY, G2RV, and LY families. Now in 2023, OMRON has revamped their relay product line, unveiling the slim G2RV-ST relay and promoting the MY-GS-R as the flagship model for the MY family.



G2RV-ST:

The relay itself is a well-known standard 6mm relay with industrial pins, but the socket has been redesigned with enhanced features, such as:

- Security lever to avoid accidental relays fall.
- Super bright Brilliant LED.
- Up to 2.5mm² cable wiring dimensions.
- Captive screw and push-in plus wiring technology available.



MY-GS-R:

The MY-GS-R is the newest member of the MY family, distinguished by its exceptional features, making it the flagship model.

These features include:

- Supreme reliability due to fully automated production.
- No polarity required for DC coil specification models with LED, available in both 2-pole and 4-pole types, simplifying wiring and maintenance activities.
- Convenient identification of AC and DC types: red test button + red LED for AC coil, blue test button + green LED for DC coil.
- 2.6mm wide pins for enhanced conductivity in MY plug-in terminals.

SOLID STATE RELAYS



Single phase SSRs with TRIAC or SCR output. Control voltage 4-32VDC or 90-280VAC, Load voltage 240VAC, 480VAC or 600VAC, Wide load current range from 10-125A.



Order Code
2770603

RELAY, 3PST-NO, 250VAC, 16A



The Finder 62 series are industrial relays. These electromechanical power relays are available in 2 and 3 poles with PCB, plug-in and faston mounting.



Order Code
1329747

RELAY, DPDT, 250VAC, 30VDC, 5A



The Omron G2RS series are industrial plug-in relays. These electromechanical power relays are slimline, space-saving relays with enhanced features mainly used for general purpose applications.



Order Code
4375350

RELAY, SPDT, 250VAC, 6A



The 39.31.0.024.0060 is a Relay Interface Module with AC/DC coil. This 39.31 series module has 1CO (SPDT), MasterBASiC electromechanical relay and 6.2mm wide. Common connection possible with optional jumper links. Accepts output fuse module 093.63 (for 5 x 20mm fuses) for quick and easy load protection.



Order Code
1169339

RELAY, SPST-NO, 250VAC, 16A



The RTS3T012 is a 1-pole general-purpose Power PCB Relay with DC coil, RT1 inrush series. 1 form-A (1NO) contact configuration. Tungsten (W) pre-make and AgSnO2 contact. Without test tab. 15.7mm high. 165A/20ms inrush peak current. 5kV/10mm coil-contact.



Order Code
9659560

RELAY, SIGNAL, DPDT, 30VDC, 1A



The TQ series from Panasonic are through hole signal relays. These mechanical relays are mainly used in signal control applications such as communications, measurement equipment, OA equipment and industrial machines.



Order Code
1175716

SSR, DIN MODULE, 60VDC, 3A



The DRA1-MPDCD3 is a 1-phase Solid-state Relay with DIN rail mount, DRA1 MP series. DC output, DC ratings 60VDC and 3A. Normally closed type output function. Cage style screw terminals for easy connection. Fits standard 35mm DIN rail.



Order Code
1784059

RELAY, 4PDT, 250VAC, 30VDC, 5A



MY(S) series miniature power relay with 4PDT contact form and DC coil.



Order Code
186466

RELAY, DPDT, 240VAC, 12A



The PT series miniature General Purpose Industrial Relay with 2-pole 12A, 3-pole 10A or 4-pole 6A, 2/3/4-form-C (CO) contacts.



Order Code
1024026

RELAY, DPDT, 240VAC, 10A; CONTACT CONFIG



General Purpose Panel/Plug-in Relays.



Order Code
1385009

SOCKET, DIN, 5MM PITCH, SCREW TERM



The RT78725 is a 8-pin Socket with screw-type terminals. It has pinning 3.5mm for DIN rail mounting and conventional terminal arrangement.



Order Code
1349721

RELAY, 4PDT, 250VAC, 7A



The 58.34.9.024.0050SMA is a 4-pole Relay Interface Module with DC coil, 58.34 series. 4CO (4PDT) contact configuration, AgNi, cadmium-free contact. Ideal interface for PLC and electronic systems. Standard for DC green LED + diode (polarity +A1). 35mm rail (EN 60715) mount, screw terminal socket.



Order Code
1169317

POWER RELAY, 24VDC, 6A, SPDT, DIN RAIL



G2RV-SR is a global standard size, low profile slim (6.2mm width) I/O relay. 25% lower profile than conventional products, contributing to a smaller control panel.



Order Code
2581778

SSR, 3A, 1-60VDC, 4-32VDC, ZERO TURN ON



The DR06D03 is a 1-phase solid-state Relay with DIN rail mount, SeriesOne DR. DC output, AC or DC control. Zero-crossing (resistive loads) or random turn-on (inductive loads) output. Fits standard 35mm DIN-rail. Load voltage ratings of 1 to 60VDC. UL 508 Endurance rating for enhanced reliability.



Order Code
2311046

RELAY, PHOTOMOS, 60V, 0.5A



The AQY21XS series from Panasonic are photoMOS relays in miniature 4pin SOP. PhotoMOS relays feature extremely low closed circuit offset voltage to enable control of low level analogue signals without distortion.













Order Code
2095723

Technical experts providing convenient, tailored and **innovative industrial sensing and connectivity solutions.**



Our Products

- | | | | | | |
|--|---|--|---|--|--|
| 
Temperature | 
Pressure | 
Flow | 
Force & Strain | 
Level | 
Data Acquisition |
| 
Test & Inspection | 
Control & Monitoring | 
Calibration Systems | 
Industrial Heaters | 
IIoT & Wireless | 
Custom & Configured |

For more info:

**OPTICAL BUBBLE SENSOR :
DETECTS LIQUID AND AIR
BUBBLES WITHOUT FAIL!**

Panasonic INDUSTRY

Optical Bubble Sensor, NPN, 2 mm Tube, 5 to 24 VDC, BE-A Series.



Order Code
4077839

**NEW! SPRING RETURN
LINEAR POSITION SENSOR,
RECTANGULAR, 12.7MM
ELECTRICAL TRAVEL, 3
PIN, 1.7KOHM, 250MW**

Sensata • BEI Sensors

Position Sensor, Spring Return, Linear, Rectangular, 12.7mm Electrical Travel, 3 Pin, 1.7kohm, 250mW.



Order Code
4069509

**MINIATURE THROUGH
BEAM PHOTOELECTRIC
SENSOR, W4F SERIES**

SICK
Sensor Intelligence.

Photo Sensor, 10 m, NPN / PNP, Push Pull, Through Beam, 10 to 30 VDC, M8 Connector, W4F Series.



Order Code
4070685

**B5WC BUILT-IN COLOR
SENSOR FOR RELIABLE
DETECTION OF CHANGES**

OMRON

Colour sensors from Omron. Improves equipment maintenance efficiency by monitoring the changes in liquid colour.



Order Code
4077838

**INTELLIGENT PARTICLE
SENSOR FOR ACCURATE
AIR QUALITY MONITORING**

Piera
SOLUTIONS

IPS-7100-1 is a photon counting readout based, highly sensitive optoelectronic particulate sensor. It is capable of fast data acquisition and readout as well as categorising particulates based on the size. Adjustable sensitivity controls provide superior accuracy and versatility.



Order Code
4015788

**SFC6000D MASS FLOW
CONTROLLER WITH
MULTI-GAS CALIBRATION**

SENSIRION

SFC6000D-20SLM is a digital mass flow controller. This measures gas mass flow by the calorimetric principle based on heat transfer. A heater element on a thermally insulated membrane and two thermopiles up-stream and downstream are integrated on a single silicon chip.



Order Code
4145353

**MAGNETIC SENSOR, FOR
T-SLOT CYLINDERS, 5 TO
30 VDC, RZT7 SERIES**

SICK
Sensor Intelligence.

Magnetic Sensor, T-Slot, 5 to 30 VDC, RZT7 Series.



Order Code
4058101

**PANEL MOUNTABLE
CURRENT TRANSDUCER**

LEM

Bipolar and insulated measurement up to 1500V.



Order Code
2664243

**NEW! DIGITAL PRESSURE
SENSOR, 16 BAR, I2C
INTERFACE, 5.5 VDC, 1/4" -
18 NPT**

Sensata
Technologies

Pressure Sensor, 16 bar, I2C Digital, Sealed Gauge, 5.5 VDC, 1/4" - 18 NPT, 3.7 mA.



Order Code
3886419

**INDUCTIVE PROXIMITY
SENSOR, IQG SERIES, WITH
COMPACT RECTANGULAR
HOUSINGS FOR USE IN HARSH
AMBIENT CONDITIONS**

SICK
Sensor Intelligence.

Inductive Proximity Sensor, IQG Series, Rectangular, 40 mm, PNP, 10 to 30 VDC.



Order Code
2776967

**Φ54 WIDE BEAM
ULTRASONIC SENSOR,
OBSTACLE DETECTION
SYSTEM, CONFIGURABLE
BY SOFTWARE**

Telemecanique
Sensors

Ultrasonic Sensor, Wide Beam, 3 m, 50° Beam, 48 kHz, 6 Pin Plug Connector, XX Series.



Order Code
4146494

**INDUCTIVE PROXIMITY
SENSOR IN XS8 FLAT FORM
DESIGN**

Telemecanique
Sensors

High-performance technology. Detection of metal objects up to 60mm.



Order Code
2847778



- Crydom
- cynergy³
- Airpax
- BEI Sensors
- Sensata

Sensata brand products & solutions, for sensing & control

THERMOMETRICS INLINE FLOW-THROUGH FLUID TEMPERATURE SENSOR

Temperature Sensor, Inline Flow Through, NTC, 10 kohm, 1 1/4" Hose Size.

Amphenol
Advanced Sensors



Order Code
3875115

Q4X RUGGED LASER DISTANCE SENSOR : THE ULTIMATE PROBLEM SOLVER

Sensor, Photo, 610 mm, Laser, Current, M12 Connector, 12 to 30 VDC.



Order Code
3765369

K50R RADAR SENSOR : SHORT-RANGE SENSOR FOR ROBUST OBJECT DETECTION

Radar Sensor, 100mm to 2.5 m, Time of Flight, NPN/PNP, 55 mA.



Order Code
3996215

COMPACT SAFETY MAGNETIC SENSORS



Safety Interlock Switch, with LED, Right Exit, MC36C Series, SPST-NO, SPST-NC, Cable, 24 V, 250 mA.



Order Code
3924668

FLUXGATE TECHNOLOGY BASED 200A CURRENT TRANSDUCER

DC200IF is a highly stabilised and precise fluxgate technology based current transducer, re-engineered for cost-sensitive, non-intrusive, isolated DC and AC current measurement applications up to 300A.



Order Code
3884205

BAS BATTERY AEROSOL SENSOR

The BAS Series Sensors are built to detect the presence and concentration of aerosols such as smoke, liquid and debris in lithium-ion battery packs.



Order Code
4144367

5000 SERIES INDUSTRIAL PRESSURE SWITCH WITH SCREW ELECTRICAL CONNECTION



78303-B00000400-14 is a 5000 series pressure switch with screw electrical connection. 5000 Series pressure switch is specifically designed to stand up to extended duty applications. This switch is factory set but capable of field adjustment.



Order Code
2373054

MINIATURE THERMOCOUPLE CONNECTOR, PLUG, IM-K-M, TYPE K, IEC

The IM-K-M (IEC) from Labfacility is a miniature thermocouple connector with flat pins to suit thermocouple type. Ideal for general purpose use.



Order Code
7086362

PT100 HEAVY DUTY SENSOR PROBE, CLASS B FOR INDUSTRIAL APPLICATIONS

The DRG 010632A from Labfacility is a Pt100 heavy duty sensor probe suitable for general purpose and commercial applications.



Order Code
8598096

3KG PULL MAGNET THERMOCOUPLE, TYPE K, IEC



The BMS-K-2-C70-MP-25.4 is a Magnet Thermocouple with 2m stainless steel over-braided PFA-PTFE cable fitted with miniature plug.



Order Code
2081298

CLAMP MOUNT INDUSTRIAL TEMPERATURE SENSOR FOR USE ON PLASTIC PIPES

Clamp Mount Temperature Sensor, Plastic, 4mA to 20mA, 0°C to 100°C, 1", Industrial, ±1.5°C.



Order Code
4145005

TURBINE FLOW METERS FOR INDUSTRIAL AND LABORATORY APPLICATION

FTB-1315 is a FTB-1300 series economical liquid turbine flow meter is designed for industrial and laboratory measurement of water, solvents and other low viscosity fluids. This series turbine flow meters features a 316 stainless steel body and a tungsten carbide bearing.



Order Code
3794985

HIGH TEMPERATURE LOW DRIFT THERMOCOUPLE INDUSTRIAL HEAD PROBE



Probe, 6", 6 mm, NB-CAXL.



Order Code
3805569

FLAT CAPACITIVE PROXIMITY SENSOR

The E2K-F10MC1 is a Flat Capacitive Sensor with excellent space efficiency. It is used for detecting ferrous metal. 50 x 50 x 1mm grounded metal plate is used as standard sensing object. The case is made of heat-resistant ABS. It provides reverse polarity and surge suppressor protection.



Order Code
1603020

BARREL-STYLE INDUCTIVE PROXIMITY SENSOR

The NBB2-12GM40-Z0 is an Inductive Proximity Sensor that is the preferred choice for the majority of applications requiring accurate, non-contact detection of metallic objects in machinery or automation equipment.



Order Code
3565312

SERIES 19N - MICROSWITCH



The miniature microswitch (the standard V4 size) has been designed in line with similar competitive products, but because of automation, offers consistent high quality levels for volume applications, at no extra cost.



Order Code
521840

V19 SERIES BASIC SWITCH



Honeywell Sensing and Internet of Things announced a new addition to their MicroSwitch products today, the V19 basic switch for appliance customers. The V19 is focused on empowering White Goods designs with a balance between configurability and cost while still providing them with a fully certified, reliable solution that is repeatable over the lifetime of the product.



Order Code
3643280

D2MQ - SUBMINIATURE BASIC SWITCH



Ultra Slim Snap-action. Switch with 2.7 mm in depth. Excellent electrical characteristics and snap action mechanism in spite of its ultra-small size. Ideal for applications where size is extremely limited and high reliability is demanded.



Order Code
9901922

NAVIMEC MODULE



Navimec is a five position navigational switch solution ideal for data entry devices where joystick function is needed. It has a select switch in the middle and four navigational switches around it. The solution is available as a module as well as single parts for own PCB mounting. Illuminated version is also available.



Order Code
1390523

SL SERIES



"The idea arose from the success story of a sealed safety interlock switch used in a deep fat chicken fryer (KFC) back in 2015 (Pressure fryers); PN SL0001-1 C&K's SL series IP67 sealed door interlock switch features push (momentary)/ pull (maintained) motion as well as SPDT and DPDT in 3 different bracket sizes (small, large and extended), multiple mounting configurations.



Order Code
3935040

KSC4 TE SERIES - TIRELESS ENDURANCE TACT SWITCH



KSC4 TE tireless endurance tactile switch is a new KSC4 configuration with J leads, a soft actuator and a renewed combination of dome and support, upgrading the lifetime up to 10 million cycles. With a size of 6.2 x 6.3 mm and actuation forces at 1.6N, 2.8N and 4N, KSC4 TE is perfect for demanding applications such as applications in the industrial segment.

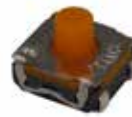

Order Code
4105498

YW SERIES CONTROL UNITS



Complete with finger-safe contact blocks. Ensure safety and save wiring time. Safety Lock Mechanism. When the emergency stop signal has been generated during actuation of the emergency stop device, the emergency stop function shall be maintained until the emergency stop device is reset (disengaged) (IEC 60947-5-5, 6.2).



Order Code
2833849

SERIES B3F



B3F Tactile Switch. Through-hole-mounting Switches in a Wide Range of Models: 6 x 6 mm, 12 x 12 mm, Side-operated Models, Gold-plated Contacts, and Radial Tape. Extended mechanical/electrical durability: 10 x 106 operations for 12 x 12 mm type and 1 x 106 operations for the 6 x 6 mm type.



Order Code
176435

V19 SERIES MINIATURE BASIC SWITCH



The V19, Honeywell's unsealed MICRO SWITCH family provides a cost-conscious switch solution to assist in hitting overall system-level cost and design goals in high volume applications. The V19 switch provides a fully certified, reliable, and repeatable solution over the lifetime of the product.



Order Code
3643264

SERIES 82 IP67 ON/OFF SWITCHES



EAO's Series 82 anti-vandal stainless steel On/Off and Standby switches are suitable for 16, 19 or 22 mm mounting and have built-in resistors for easy direct connection to a 12V or 24V supply. These attractive switches offer excellent tactile feedback, in either non-illuminated versions, with ring illumination or with symbol illumination.



Order Code
3975967

PTS645 SERIES - 6 MM TACT SWITCHES



Designers for power tooling, set top and access boxes, instrumentation and general consumer products turn to C&K's PTS645V series of 6mm SMT side actuated tact switches to give their products the reliability and long life demanded by regular use.



Order Code
2320089

XB4BD21



Harmony, 22mm Push Button, 2 position selector switch, black, maintained, 1 NO, 600 V.



Order Code
2518114

C3SS



SELECTOR SWITCH#C3SS. Compact Selector Switch.



Order Code
2911783

SERIES 59



The Series 59 is a range of miniature, momentary action, rugged panel sealed pushbutton switches. The Series is available with square or round bezel versions, with or without LED status illumination and in a variety of button types.



Order Code
4434444

PVK4 ANTI-VANDAL SELECTOR SWITCH



Selector Switch Anti-vandal DPDT On-On 2A 24VDC, 2 Position return On-(On), Red Led illumination, Base voltage. Keylock Switch DPDT On-On-On 2A 24VDC, 3 Position maintains On-On-On.



Order Code
4067363

IP67 16MM ANTI-VANDAL SWITCHES

multicomp PRO

LED for easier sensor setup and troubleshooting, IP67 rated.



Order Code
3104419

IP67 19MM ANTI-VANDAL SWITCHES

multicomp PRO

Stainless steel momentary & maintained switches with a 19mm panel cut out diameter. Available as either 1NO 1NC or 2NO 2NC, with two different top types; flush or domed and in three different colours; green, red and blue.



Order Code
3104463

IP65 19MM ANTI-VANDAL SWITCHES

multicomp PRO

Stainless steel momentary & maintained prominent top type switches with a 19mm panel cut out diameter. Available as either 1NO 1NC or 2NO 2NC, and in three different colours; green, red and blue.



Order Code
3104469

IP65 22MM & 30MM ANTI-VANDAL SWITCHES

multicomp PRO

Stainless steel momentary & maintained flush top type switches with either a 22 or 30mm panel cut out diameter. Available with 1NO, 1NC, 2NO, 2NC, or 1NO 1NC and in three different colours; green, red and blue.



Order Code
3104506

ILLUMINATED EMERGENCY STOP SWITCHES

multicomp PRO

IP65 E-Stop switches with Push-Pull operation and various contact configuration options including DPST-NC, DPST-NO, SPST-NC, SPST-NO, SPST-NO, SPST-NC.



Order Code
2748237

SERIES MPI002 - VANDAL RESISTANT SWITCH

bulgin

Manufactured from Stainless Steel, Bulgin's extensive range of vandal resistant security switches are designed with a high resistance to wear and tear, corrosion and harsh use in potentially hostile environments such as access control applications.



Order Code
1454959

SERIES MP0037 - VANDAL RESISTANT SWITCH

bulgin

Manufactured from Stainless Steel, Bulgin's extensive range of vandal resistant security switches are designed with a high resistance to wear and tear, corrosion and harsh use in potentially hostile environments such as access control applications.



Order Code
560431

SERIES MPZ022 - PIEZO ANTI VANDAL SWITCHES

bulgin

Unlike traditional switches Piezo switches have no moving mechanical parts making them extremely durable, withstanding millions of actuations and requiring little to no maintenance.



Order Code
2448383

MRSS SERIES - MINIATURE ROTARY SWITCH

TE
AUTHORIZED DISTRIBUTOR

The MRSS addresses manual programming applications. These high-quality rotary DIP switches are available in size 7.7mm square (horizontal) and 7.2mm square (vertical) for a wide range of possible applications like an elevator and security system.



Order Code
4077894

PBES16L SERIES - EMERGENCY STOP SWITCH

IDEC

Illuminated (with or without lamp) Solder to wire or quick connect disconnect terminals Compact size (space saving) and Simple easy mounting. The PBES16 Series has a 20N actuation force for ruggedized applications to avoid accidental actuations and is also IP65 rated to withstand harsh environments.



Order Code
1706784

PBES16N SERIES - EMERGENCY STOP SWITCH

IDEC

Non-Illuminated. Solder to wire or quick connect disconnect terminals. Compact size (space saving) and Simple easy mounting. The PBES16 Series has a 20N actuation force for ruggedized applications to avoid accidental actuations and is also IP65 rated to withstand harsh environments.



Order Code
2833850

SERIES 45 - EMERGENCY STOP SWITCHES

eao

Series 45 emergency stop switches offer reliable protection for both man and machine in the event of application malfunctions - on a factory conveyor belt, for instance. Thanks to intuitive operation and IP69K rated features, these switches perform safely and securely as often required in harsh, industrial environments.



Order Code
3648372

ST4 SERIES - SEALED TOGGLE SWITCH

E+SWITCH

The ST4 Series sealed toggle switches are rated IP68 for dust and moisture protection and offer single pole or double pole circuit functions with 2 or 3 actuator positions. Select from 10 different function options, three electrical rating options, and 17mm metal or 22mm plastic bat actuator.



Order Code
3779928

ST5 SERIES - HIGH TEMPERATURE TOGGLE SWITCH

E+SWITCH

The ST5 series toggle switch series can handle temperatures ranging from -10°C to 125°C. The ST5 offers a single pole or double pole circuit function with two or three positions and offers three electrical rating options.



Order Code
3861216

KJD17 SERIES HEAVY DUTY, INDUSTRIAL POWER PUSHBUTTON SWITCH

E+SWITCH

The KJD17 Series is a heavy-duty industrial pushbutton switch. Its electromagnet provides automatic safety protection against power outages and restarts. A PVC cap is available for dust and water protection. This heavy-duty industrial pushbutton switch has 2HP electrical ratings and is UL listed.



Order Code
4051016

LOOP CALIBRATOR



Hand-held loop calibrator with stable performance and up to 0.02% high accuracy. Measures DC voltage/current and loop current, source/simulate DC current. Designed with auto stepping and ramping, the 25% stepping function can be used for fast linearity detection.



Order Code
3014337

IMPEDANCE METER, 30VAC TO 600VAC, RCD



The MP780430 from Multicomp Pro is a digital RCD (ELCB) tester, featuring LCD backlit screen, 30 to 600VAC AC voltage measuring range and 45 to 65hz frequency measuring range.



Order Code
3394757

EARTH GROUND CLAMP METER, 0.01OHM-1.2KOHM



MP760838 is a clamp earth ground resistance tester, used for testing grounding resistance. This device can quickly and safely measure the grounding system without disconnecting circuit ground lines or the needs of auxiliary electrodes.



Order Code
3779342

HUMIDITY METER, 0-100%RH (SPLIT-TYPE PROBE)



The MP780117 from Multicomp Pro is a handheld temperature humidity meter, featuring split-type probe and probe holder.



Order Code
3267129

CARBON MONOXIDE METER



This is a portable meter for detecting carbon monoxide gas. It can measure a wide range of CO concentrations with a short response time. Users can set up both audio and visual alarms.



Order Code
3977121

HANDHELD DIGITAL MULTIMETERS



The MP730651 is a 1000V true RMS digital multimeter which offers high levels of reliability and security, with a 6000 count display. With a large screen, high resolution analogue pointer display, full scale overload protection and unique appearance design, the device is an extremely practical electrical measuring meter.



Order Code
3677286

MINI AC LEAKAGE CURRENT TESTER, 200A



Miniature AC leakage current test meter with LCD display, 30mm shielded transformer jaw and a data hold function that allows for easy reading in dimly lit locations.



Order Code
3126627

FIBRE OPTIC TESTER, -50DBM-26DBM



The MP700122 from Multicomp Pro is a handheld optical power meter, used to measure absolute optical power or relative loss of optical power through the length of fibre optic wires.



Order Code
3267134

COMPACT WEIGHING SCALE, 100G



Compact balance, suitable for weighing, parts counting, percentage weighing and accumulation of weight.



Order Code
3583599

IR / INFRARED THERMOMETER, -20°C-400°C



The MP780003 from Multicomp Pro is a miniature infrared thermometer, capable of temperature measurements between -20°C and +400°C (-4°F to 752°F) with an accuracy of ±2%.



Order Code
3014335

THERMOMETER, DUAL INPUT, J, K, T, E, S, R & N THERMOCOUPLES



MP780832 is a dual input thermometer offering compatibility with type J, K, T, E, S, R & N thermocouples.



Order Code
3777598

BENCH DIGITAL MULTIMETER, 3.75, 10 A, 1 KV, 60 MOHM



MX 5006 multimeter is equipped with classic functions voltage, current, resistance, continuity, diode test, this multimeter can also measure the capacitance, frequency, period and relative values expressed in value terms and as percentages.



Order Code
2945495

SOUND LEVEL METER, 30 DB, 130 DB, 1 DB, 0.1 DB, 0 °C, 40 °C



Sound Level Meter, 30 dB, 130 dB, 1 dB, 0.1 dB, 0 °C, 40 °C.



Order Code
3527960

VIBRATION METER, 10HZ TO 1KHZ, 180 MM, 72 MM, 32 MM



Dual Input Datalogging Thermometer w/ Alarm-Built-in PC interface with internal memory stores up to 16 data sets, 1024 maximum capacity With Programmable Hi/Lo audible alarm.



Order Code
2836699

VIBRATION METER, 100MV/G, 10HZ TO 1KHZ, 80KHZ, 0.241 MM, 0.071 MM, 0.058 MM



The Fluke 805 is not a vibration pen; it's a meter. A Fluke meter that eliminates the confusion of vibration screening and provides reliable measurements you can trust to make critical go or no-go maintenance decisions.



Order Code
2114858

CLAMP METER, AVERAGE RECTIFIED, 42 A TO 1 KA, 600V, AC A, AC+DC V, RESISTANCE
HIOKI

3280-10F is an average rectifying 1000A AC clamp meter that features a broad operating temperature range of -25°C to 65°C, thin and compact clamp core and optional flexible current sensor that you can attach to let you get into the tightest spots.



Order Code
3234209

IP67 DIGITAL MULTIMETER, U1240C SERIES, 10000 COUNT, TRUE RMS, AUTO, MANUAL RANGE, 4 DIGIT

The U1242C is a 4-digit Handheld Digital Multimeter with an IP67 protection. It is designed for handheld users working in various environments. It can be capable to withstand up to 3m (10-feet) drop to suit harsh working environments.



Order Code
2499698

ANEMOMETER, 0.4M/S TO 20M/S, -10 °C, 50 °C, 0% TO 100%, 133 MM

Testo 410-1 measures air speed and temperature. It is ideal for quick spot checks at air outlets on account of its integrated measurement with the 40mm vane. Timed mean calculation is possible. In addition to air speed and temperature, testo 410-2 also measures air moisture.



Order Code
1471402

AIR QUALITY METER, -5 °C, 50 °C, 0.1% TO 90%, OPPM TO 9999PPM

A desktop air quality monitor for use in schools, office buildings, greenhouses, factories, hotels, hospitals, transportation lines or anywhere that where high levels of carbon dioxide may be generated.



Order Code
2836701

AIR QUALITY METER, -20 °C, 60 °C, 0% TO 95%, OPPM TO 40000PPM

EL-WEM+ is a Wi-Fi CO2 and Indoor Air Quality (IAQ) monitor from EasyLog is the ideal device for ensuring adequate levels of air quality at work and home.



Order Code
4059626

HUMIDITY METER, 5% TO 95% RELATIVE HUMIDITY, 0.1 °C, 194 MM, 60 MM, 34 MM

Temperature and humidity are two important factors in maintaining optimal comfort levels and good indoor air quality. Quickly and conveniently take accurate humidity and temperature readings with the Fluke 971.



Order Code
1147977

HUMIDITY METER, 10% TO 99% RELATIVE HUMIDITY, 5 %, 38 MM, 51 MM, 16 MM

Mini hygro-thermometer monitor ideal for monitoring temperature and humidity conditions in enclosed or open space environments. It helps gauge proper heat and moisture levels and it also records high and low extremes during the day.



Order Code
3018732

CLAMP METER, AC LEAKAGE, 60 MA TO 600A (5 RANGES), 40 HZ TO 1000 HZ, 24 MM CORE DIAMETER

CM4001 is a small AC leakage clamp meter that especially allows for precise measurements within crowded cable arrangements or cabinets. Despite its compact dimensions the slim design of the jaws allow for cables with a diameter of up to 24mm.



Order Code
3527151

CLAMP METER, TRUE RMS, 400 A AC, 600 V DC, 30 MM JAW OPENING MAX.

FLUKE 325 is a true RMS clamp meter. True-rms measurements and optimised ergonomics make the 320 series clamp meter the best general troubleshooting tools for commercial and residential electricians.



Order Code
2215022

CLAMP METER, TRUE RMS, 600 A AC, 1 KV DC, 34 MM JAW OPENING MAX.

The Fluke 374 FC offers advanced troubleshooting performance and is part of the Fluke Connect family of wireless test tools.



Order Code
2507341

CLAMP METER, AC / DC, BUILT IN NON-CONTACT VOLTAGE (NCV) DETECTOR, TRUE RMS, 400 A

Compact clamp meter with non-contact voltage detector and type K is suitable for use in a range of applications akin to conventional handheld multimeters but with an integrated NCV detector.



Order Code
2836720

HUMIDITY METER, 10% TO 95% RELATIVE HUMIDITY, 3 %, 0.1 °C, 111 MM, 90 MM, 40 MM

The affordable standard testo 608-H1 hygrometer continuously measures humidity, temperature and dewpoint.



Order Code
3695797

LIGHT / LUX METER, 400000 LX, 0.01 LX, 5 %, 150 MM, 75 MM, 40 MM

Light Meter-Measures light intensity up to 20,000 Foot-candles or 200,000 Lux with high resolution to 0.01 Fc/Lux.



Order Code
2836717

LIGHT / LUX METER, 200000 LX, 0.01 LX, 3 %, 130 MM, 63 MM, 38 MM

The Amprobe LM-120 light meter measures the visible light from fluorescent, metal halide, high-pressure sodium or incandescent sources. It is a portable, easy-to-use digital light meter designed for simple one-hand operation reading in Lumen (lux) or foot candle (fc) units.



Order Code
1671223

SOUND LEVEL METER, 2000 COUNT, LCD, 40 DB, 130 DB, 2 DB, 0.1 DB

Dual Input Datalogging Thermometer w/ Alarm-Built-in PC interface with internal memory stores up to 16 data sets, 1024 maximum capacity with Programmable Hi/Lo audible alarm.



Order Code
2836698

TECHNICIANS DIGITAL MULTIMETER, 110 SERIES, 6000 COUNT, TRUE RMS, AUTO, MANUAL RANGE



For general purpose electrical and electronic test requirements, the Fluke 115 True-RMS digital multimeter provides the perfect answer. Its simple operation, compact design and ease of use makes it perfect for quick verifications and field service use.

Order Code
1274599

DIGITAL MULTIMETER, FLUKE 170 SERIES, 6000 COUNT, TRUE RMS, AUTO, MANUAL RANGE, 3.75 DIGIT



The Fluke 175 digital multimeter has the features needed to find most electrical, electro-mechanical and heating and ventilation problems. They are simple to use and have significant improvements over Fluke's original 70 Series like, True-RMS, more measurement functions, conformance to the latest safety standards.

Order Code
3558678

SOLDERING FUME EXTRACTOR, DOUBLE PIPE

multicomp PRO



MP740530 is a double channel 200W fume extractor, with maximum air flow volume of max 360m³/h. With an integrated airframe design, metal frame cold rolled steel plate electrostatic design, making it durable.

Order Code
3517219

HOT AIR SMD REWORK STATION, EU/UK PLUG

multicomp PRO



This Rework Station has a wide range of adjustments of the airflow rate and temperature permitting soldering and disordering of SMDs; closed-loop control of temperature; automatic cooling mode – protects the heating element and handle when the power switch is turned off.

Order Code
4058508

MICROBOX DRILL BIT SET

multicomp PRO



20-piece drill set (0.3 – 1.6mm). This 20-piece set contains high quality HSS ground drills. Features a handy slide-top box which releases only the chosen drill.

Order Code
3350693

JSS JOBBER DRILL SETS

multicomp PRO



HSS 0.3mm drill bit set. HSS bits are hard, and much more resistant to heat than high carbon steel. They can be used to drill metal, hardwood, and most other materials at greater cutting speeds than carbon steel bits, and have largely replaced carbon steels.

Order Code
3350695

BALL END HEX KEYS

multicomp PRO



Ball end hex keys, sizes ranging from 1.5mm to 10mm and 0.05" to 5/16".

Order Code
3404769

VDE HEX KEY SETS

multicomp PRO



This Multicomp Pro Key Sets is VDE Certified for live working up to 1000V AC / 1500V DC. All Keys are stored in the blow mold protection case. The range of keys is in within Metric Sizes : 2.5mm, 3mm, 4mm, 5mm, 6mm & 8mm.

Order Code
3404793

ESD PLIERS

multicomp PRO



Range of 4 ESD pliers, with varying noses including round, snipe and chain.

Order Code
3577614

PLIERS - VARIOUS

DURATOOL



Range of 4 pliers in varying spec, including 6" nipper, 6" diagonal and miniature versions of each 4.5".

Order Code
2444462

4-IN-1 SCREWDRIVER



4-in-1 screwdriver with cross and slotted screwdriver bit and comfortable grip.

Order Code
2213713

3-PIECE TAP SETS

multicomp PRO



This Multicomp Pro Tap Sets includes 3 piece set in a plastic box. Taps are made from premium quality HSS material. For cutting threads in steel & similar materials.

Order Code
3703249

RASPBERRY PI 4 DIN RAIL MOUNT ENCLOSURES

multicomp PRO



No screws, no glue – just add your Raspberry Pi filling! Great way to industrialise your Pi 4 with room for a Pi HAT.

Order Code
3243146

PI-BOX PRO 4

multicomp PRO



1U 19" Rack Fronts with rugged industrial enclosure kits for the Raspberry Pi4. Available in 1, 2 or 3 case units.

Order Code
3772120

MP-BED CABINETS

multicomp PRO



UL approved ABS-HB lockable cabinets supplied complete with galvanised steel cak plate and mounting brackets. IP65 & IK08 protection makes them suitable for wide range of harsh, dry, dusty or high-humidity environments. Solid and Transparent door options.

Order Code
3263865

**KRAFTFORM KOMPAKT 62
SCREWDRIVER BIT SET**



Pouch with 89-mm long bits. Includes 816 R Kraftform holder with Rapidaptor quick-release chuck and multi-component Kraftform handle for low-fatigue working. Suitable for manual and power tool operations; 33-piece.



Order Code
7621221

**ZYCLOP SPEED RATCHET
SET**



Incredibly compact set arrangement with many tools in a minimum space. The Wera Zyklop Speed ratchet combines the advantages of five different types of ratchet in one. "Take it easy" Tool Finder with colour coding according to sizes.



Order Code
2426004

**12 42 195 SELF ADAPTING
WIRE STRIPPER**



Fully automatic adjustment to all single-, multi- and fine-stranded conductors with standard insulation throughout the entire capacity range from 0.03 to 10.0 mm².



Order Code
8156921

**90 22 10 BK BIX PIPE AND
TUBE CUTTER**



Cuts pipes quickly, cleanly and without shavings. Cuts unreinforced plastic pipes from Ø 20mm to 50mm with a wall thickness of up to 2.4 mm or soft plastic pipes and those with foamed cores from Ø 20mm to 50mm with a wall thickness of up to 3.5mm.



Order Code
3779550

**16 95 01 SB ERGOSTRIP®
DISMANTLING TOOL**



For fast and precise stripping of all common round and damp-proof installation cables, data cables and coax cables.



Order Code
2545679

**7000SK65ESD MICRO BIT
SET, 65 PIECES**



The 7000SK65ESD is a 65-piece Microbit Set with ESD precision handle. Contents - 45 x Micro bits, 16 x Micro sockets, 4mm Driver, ESD turning handle, Bit holder, Adapter, Ratchet.



Order Code
2469986

**SB 369 SZ 13B BALL END
HEX KEY SET**



The SB 369 SZ 13B is a 13-piece ballpoint hexagonal L-Key Set in ProStar. The set with manganese-phosphated chrome-vanadium steel, through hardened blade, space saving ProStar allows the easy removal of each key without moving any others.



Order Code
3584598

**T3442M 5 SOFTECH 5M
METRIC TAPE MEASURE
WITH LOCK AND PAUSE
BUTTON**



Tough ABS plastic body for damage protection. Full lock & pause buttons for control. Belt clip for convenience. True zero hook for accurate external & internal measurements.



Order Code
1521873

**T3064B DRILL BIT SET -
METAL, WOOD & MASONRY**



The T3064B is a Combined Drill Bit Set for fast and efficient drilling of wood, metal and brick. Contents: For Brick: 4, 5.5, 6.5, 7, 8 mm. For Metal: 2, 3, 4, 5, 6, 8 mm. For Wood: 4, 5, 6, 8, 10 mm.



Order Code
2494928

**440007 VOLTAGE MAINS
TESTER**



VDE approved mainstester for assured safety. Neon light for high visibility. Blade: 3 x 65 mm.



Order Code
1098821

**8710E FFP1 RESPIRATOR.
PACK OF 20.**



For use against dusts found in a wide variety of industrial and other work situations, requiring FFP1 level protection. Features two self-adjusting straps and a cushioned nose area.



Order Code
1569357

**ES-01-001 EARPLUGS,
PACK OF 250 PAIRS**



The ES-01-001 is a regular size yellow uncorded Neon Earplug made of soft, slow-recovery foam (polyurethane) for excellent noise reduction and comfort. A plug that gives evenly distributed pressure allowing flexibility and a good seal with optimum comfort. Brightly coloured earplug is easy to spot in compliance checks.



Order Code
1373100

**SOLUS 1000 PROTECTIVE
GLASSES**



Solus™ 1000 Series Eyewear with Scotchgard™ Anti-Fog Coating. Scotchgard™ Anti-Fog coating is designed for working in challenging situations such as hot & humid conditions, indoor & outdoor work, physically demanding tasks and climate-controlled areas.



Order Code
2675851

PELTOR X EAR DEFENDERS



Offering 27, 39 or 40.3dB attenuation, the Peltor X series offers Moderate attenuation ideal for low-to-moderate noise exposure. Noise exposure.



Order Code
2675823

PU COATED NYLON GLOVES



PU Coat Nylon Gloves offer fantastic fit making them perfect when you need great sensitivity and dexterity. With a PU coating for extra grip, these gloves are ideal for general and precision tasks.



Order Code
3498238

2.35MM SHANK DRILLS



HSS 2.35mm shank drill bit set, 0.5mm 3-piece. HSS drill bits for precision drilling work in wood, metals and plastics.



Order Code
3350707

HEAT GUN, 1.8KW, EU/UK PLUG



MP003076 from Multicomp Pro is a 1800W heat gun with UK plug. Includes nozzle set and sturdy carry case. CE/GS/EMC approved.



Order Code
3386084

T-HANDLE HEX KEYS



T-handle hex keys, ranging in sizes from 2mm to 6mm.



Order Code
3404756

INDUSTRIAL HIGH POWER HEADLIGHT



The PS-HDL9R is a 750 lumen LED ultra bright head torch and is operated via an easy twist side dimmer switch. Its rear battery pack is powered by either 1 or 2 lithium-ion rechargeable 18650 batteries and contains a rear red warning light.



Order Code
2853447

200 W LED FLOODLIGHT



Floodlight with a wide beam, asymmetric light distribution for various application areas.



Order Code
3758935

PRECISION BALANCE PCB



PCB 350-3 is a compact laboratory balance. It features PRE-TARE function for manual subtraction of a known container weight, useful for checking fill-levels. With the recipe function you can weigh the different ingredients of a mixture.



Order Code
3811484

60 DRAWER STORAGE CABINET



Cabinet with drawers of type 150-00. Each drawer can be divided into 4 compartments using dividers (extra accessory).



Order Code
137386

VELCRO® ONE-WRAP REUSABLE TIES ROLL



Get organised with VELCRO® Brand ONE-WRAP® Reusable Ties! Perfect for indoor and outdoor use, this pack contains a black 5m roll that can be cut to the size you need. Perfect for use at home, on site or in the workplace, use these wide VELCRO® Brand ties to keep larger wires and cables tidy.



Order Code
3499709

A2 STAINLESS STEEL SCREWS



Stainless steel product does not rust or tarnish and gives a more aesthetically pleasing finish. It has a long-life cycle and is also more environmentally friendly as it is 100% recyclable.



Order Code
4156260

A2 STAINLESS STEEL WASHERS



Stainless steel product does not rust or tarnish and gives a more aesthetically pleasing finish. It has a long-life cycle and is also more environmentally friendly as it is 100% recyclable.



Order Code
4157329

A2 STAINLESS STEEL NUTS



Stainless steel product does not rust or tarnish and gives a more aesthetically pleasing finish. It has a long-life cycle and is also more environmentally friendly as it is 100% recyclable.



Order Code
4156221

KRAFTFORM KOMPAKT W1 MAINTENANCE KIT



Wera Kraftform Kompakt W1 maintenance Kit includes the most important screwdriving tools for maintenance jobs both indoors as well as outdoors. It is supplied in a surface-protecting, highly robust textile box. It has a compact and light weight design for simplified mobility.



Order Code
2493787

TORQUE DRIVER SET



Wera torque screwdriver set. Two high precision torque screwdrivers with variable torque settings, one torque screwdriver with Kraftform pistol handle for the transfer of especially high torque. Includes a bit assortment in high quality and stable plastic case.



Order Code
1337766

JOKER WRENCH SET



High-quality combination ratchet wrench set by Wera: everything that a wrench has to be able to do. And a whole lot more. The new generation of combination ratchet wrenches. 11-piece set in a robust pouch. Suitable for hexagon bolt heads or nuts.



Order Code
2362592

TOOL-CHECK PLUS SOCKET & BIT SET



Combination tool consisting of a ratchet, bits, sockets and holder in a minimum of space. Ideal as a universal companion for a whole host of screwdriving applications.



Order Code
2425994

DOWSIL 3140 RTV COATING



One-part, translucent adhesive or coating with good flowability, high elongation value for vibration/mechanical shock dampening and low stress, good flame resistance, UL, IPC and Mil Spec tested, contains UV indicator.

Order Code
536738



DOWSIL 732 MULTI-PURPOSE SEALANT



General-purpose acetoxy RTV sealant for industrial sealing and bonding applications.

Order Code
2289628



AS1803 1 PART NON-CORROSIVE NEUTRAL CURE ADHESIVE SEALANT



This is a non-corrosive, neutral cure, 1-part, RTV (Room Temperature Vulcanising) silicone adhesive sealant. It is one in a range of Acetone cure products which are solvent free.

Order Code
8497400



3M COPPER FOIL TAPE 1181



3M Copper Foil Tape 1181 consists of a 1-ounce rolled copper foil backing and an electrically conductive, pressure-sensitive acrylic adhesive. This tape is supplied on a removable liner for easy handling and die-cutting. It has excellent solder ability.

Order Code
1208991



3M POLYIMIDE FILM TAPE 5413



3M Polyimide Film Tape 5413 with DuPont™ Kapton® polyimide film and silicone adhesive used for PCB solder masking and other high temperature applications. This product is amber colored and 2.7 mil (69 microns) thick.

Order Code
3227416



3M SCOTCH SUPER 33+ VINYL ELECTRICAL TAPE



Electrical Insulation Tape, PVC (Polyvinyl Chloride), Black, 19.05 mm x 20.12 m, premium grade, super 33+ 7mil thick, all-weather vinyl insulating tape.

Order Code
143078



TESA 51408 FLAME RETARDANT KAPTON® HIGH-GRADE MASKING TAPE



tesa® 51408 (Kapton® backing with silicone adhesive) is a highly temperature-resistant and high grade adhesive tape.

Order Code
1775817



MOLYKOTE 4 ELECTRICAL INSULATING COMPOUND



A moisture-proof seal for transportation and industrial applications, including ignition systems, sealed electrical connectors, disconnect junctions and terminals where a semi-flowable consistency material is appropriate.

Order Code
537019



MOLYKOTE 33 MEDIUM EXTREME LOW TEMPERATURE GREASE



Molykote 33 is a lubricating grease for metal/metal, metal/plastic combinations involving slow to medium-fast movements and light load, especially over a wide range of temperatures.

Order Code
3605776



MOLYKOTE 55 O-RING GREASE



Silicone-based material that helps ensure positive lubrication and sealing by slightly swelling rubber O-rings and seals. This product is heat-stable and oxidation-resistant.

Order Code
3605778



847 CARBON CONDUCTIVE ASSEMBLY PASTE



847 is a carbon-filled electrically conductive paste. It improves electrical connections between non-moving parts in the same way a thermal paste improves thermal connections. It will not separate, bleed or migrate.

Order Code
2811926



LOCTITE 222 THREADLOCKING ADHESIVE



Threadlocking Adhesive - low strength. Easy disassembly. Suitable for all metal threaded assemblies.

Order Code
537056



LOCTITE 406 INSTANT ADHESIVE



LOCTITE 406 is a low viscosity, fast-curing instant adhesive that is ideal for bonding plastics and elastomeric materials where very fast fixturing is required.

Order Code
1676331



LOCTITE 5145 ADHESIVE SEALANT



Loctite 5145 is a translucent, non-slumping, room temperature-vulcanising liquid alkoxy silicone adhesive and sealant specifically formulated for bonding, sealing and coating electronic devices in military, automotive and industrial electronics.

Order Code
3072393



DOWSIL 3145 RTV MIL-A-46146 ADHESIVE / SEALANT



One-part, moisture RTV, non-flow, high strength, UL and Mil Spec.

Order Code
8793492



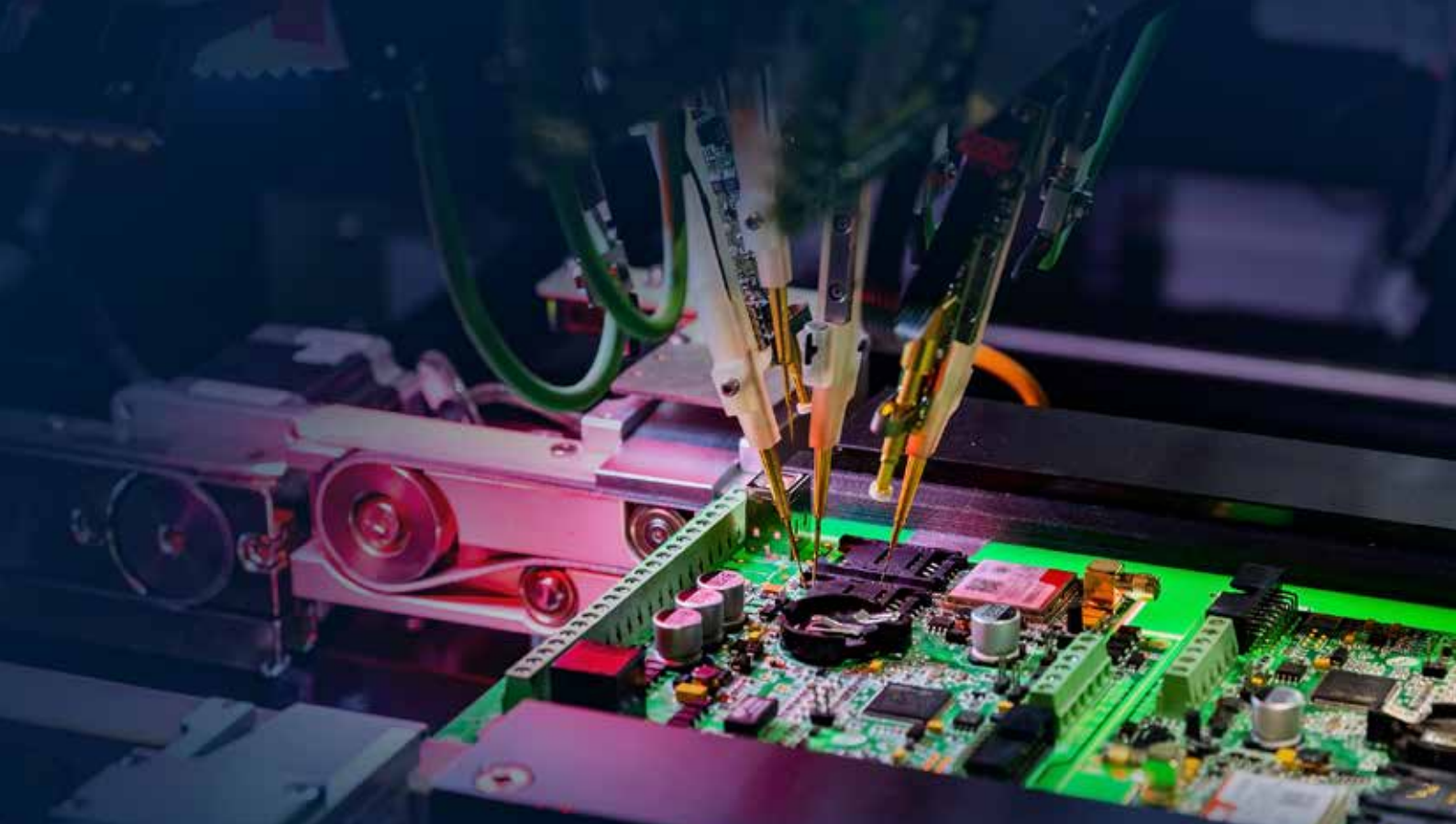

INDUSTRIAL EMBEDDED COMPUTERS

Enabling Next Generation of Industrial Applications

We offer the latest cutting-edge industrial embedded computers designed for use in today's most demanding industrial IoT and edge computing environments.

To give you peace of mind, our industrial computers help reduce downtime and prevent failures. Embedded computers from industry-leading suppliers are available in a variety of form factors that are ideal for space-constrained implementations and are engineered for performance and reliability.



Rugged for harsh environments



Multiple connectivity



Compact form factors



Compliance and support



Long time availability



Extended I/Os

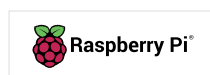

RASPBERRY PI COMPUTE MODULE 4 IO BOARD



The Raspberry Pi Compute Module 4 IO Board (CM4IO) is designed to assist in the development of products that make use of the Raspberry Pi Compute Module 4.

Order Code
3563491

RASPBERRY PI COMPUTE MODULE 4, 8GB RAM, 32GB EMMC, WITH WIFI AND BLUETOOTH



Raspberry Pi Compute Module 4 harnesses the compute power of the popular Raspberry Pi 4 Model B, bringing it to a smaller form factor suitable for integration into products.

Order Code
3585683

ARDUINO PORTENTA H7



Program it with high-level languages and AI while performing low-latency operations on its customisable hardware.

Order Code
3404698

ARDUINO PORTENTA X8



The groundbreaking Portenta X8 is a powerful, industrial-grade System On Module (SOM) with Linux OS preloaded onboard, making it a plug-and-play solution capable of running device-independent software.

Order Code
3994324

PORTENTA MACHINE CONTROL BOARD



The Portenta Machine Control is a fully-centralised, low-power, industrial control unit able to drive equipment and machinery.

Order Code
3775892

BEAGLEBONE BLACK



BeagleBone Black is a development platform for developer. Boot Linux in under 10 seconds and get started on development in less than 5 minutes with just a single USB cable.

Order Code
3520081

BEAGLEBONE BLACK INDUSTRIAL



BeagleBone Black Industrial answers the need for an industrial rated single board computer with extended temperature range.

Order Code
3520083

LATTEPANDA V1, 4GB/64GB, WIN10 ENTERPRISE



4GB RAM LattePanda Windows 10 mini PC with 64GB eMMC memory. This model of LattePanda V1 - 4GB/64GB includes an activated edition of Windows 10 Enterprise LTSC.

Order Code
3517829

LATTEPANDA 2 ALPHA 864S, 8GB/64GB, WIN10 PRO



LattePanda 2 Alpha 864s (Win10 Pro activated) is a high-performance, pocket-sized SBC (single board computer) with low power consumption that runs full Windows 10 or Linux operation system.

Order Code
3517855

LATTEPANDA 3 DELTA BOARD, 8GB/64GB, WIN 10



LattePanda 3 Delta 864 - The Fastest Pocket-sized Windows/Linux Single Board Computer with Win10 Enterprise License (8GB/64GB).

Order Code
3954474

NVIDIA JETSON NANO MODULE, 4GB/16GB



The NVIDIA® Jetson Nano™ module is opening amazing new possibilities for edge computing. It delivers up to 472 GFLOPS of accelerated computing, can run many modern neural networks in parallel. The system-on-module is powered by the NVIDIA Maxwell™ GPU with 4 GB of memory, which allows real-time processing of high-resolution inputs.

Order Code
4126467

NVIDIA JETSON XAVIER NX MODULE, 8GB/16GB



With 8GB RAM and 16GB EMMC the NVIDIA® Jetson Xavier™ NX brings supercomputer performance to the edge in a compact system-on-module (SoM) that's smaller than a credit card. It delivers up to 21 TOPS for modern AI workloads with NVIDIA's unified software architecture.

Order Code
4126468

NVIDIA JETSON XAVIER NX MODULE, 16GB/16GB



With 16GB RAM and 16GB EMMC the NVIDIA® Jetson Xavier™ NX brings supercomputer performance to the edge in a compact system-on-module (SoM) that's smaller than a credit card. It delivers up to 21 TOPS for modern AI workloads with NVIDIA's unified software architecture.

Order Code
4126469

NVIDIA JETSON XAVIER DEVELOPER KIT, 8GB/16GB



With 8GB RAM and 16GB EMMC the reComputer J20-series are compact edge computers built with NVIDIA advanced AI embedded systems: Jetson Xavier NX and Seeed reference carrier board (J202).

Order Code
4122509

EDGEBOX-RPI-200 - INDUSTRIAL EDGE CONTROLLER 4GB RAM, 16GB EMMC, WIFI



EdgeBox-RPI-200 series are all-in-one Raspberry Pi-based industrial edge computing controllers, combining multiple industrial purposes.

Order Code
4126474

TRI-RATED CABLE



The PP001188 from Pro Power is a single core, black colour tri-rated flexible PVC equipment wire supplied in continuous length in 1 metre multiples. This high temperature, flame retardant wire is designed to use in switch control, relay and instrumentation panels of power switchgear.



Order Code
2528084

UL HOOK-UP WIRE



A comprehensive range of UL approved Hook-Up wire available in multiple colours and wire sizes. Choose between UL 1007, 1015, 1061, 1569 and 1571.



Order Code
2986723

INDUSTRIAL AUTOMATION AND PROCESS CONTROL CABLES



Industrial range of SY, CY & YY control cables, and PUR, SERVO, DeviceNet and BUS networking cables. Meets VDE, IEC, DIN EN, BS EN standards.



Order Code
2827538

OLFLEX 110 MULTICORE CONTROL CABLE



Multicore Cable, Ölflex® YY, Unscreened, 3 Core, 19 AWG, 0.75 mm², 164 ft, 50 m.



Order Code
1179042

ETHERLINE CAT5E NETWORKING CABLE



Networking Cable, Etherline, Screened, Cat5e, 26 AWG, 0.14 mm², 328 ft, 100 m.



Order Code
1285779

PRO-MET CY CONTROL CABLE



Multicore Cable, Pro-Met®, CY Control, Screened, 3 Core, 15 AWG, 1.5 mm², 328 ft, 100 m.



Order Code
2947503

ECOFLEX PUR MULTICORE CABLE



Multicore Cable, EcoFlex® PUR, Unscreened, 3 Core, 10 AWG, 5.21 mm², 100 ft, 30.5 m.



Order Code
2945868

RS-485 CABLE



Multipair Cable, Computer, Screened, 2 Pair, 24 AWG, 0.2 mm², 498.69 ft, 152.4 m.



Order Code
961735

MACHFLEX 350 SY CABLE



Multicore Cable, Screened, 7 Core, 1.5 mm², 164 ft, 50 m.



Order Code
2912062

HARNESS BOARD ELASTIC RETAINER



Harness Board Elastic Retainer, Screw Mount, Black Nylon 6.6, For 31.75mm Max. Bundle Dia.



Order Code
2764500

SINGLE WALL HEAT SHRINK TUBING



Heat Shrink Tubing, Flame Retardant, 2:1, 0.188", 4.8 mm, Black, 29.5 ft, 9 m.



Order Code
1210566

HEAT SHRINK EDGING



Grommet, Strip, 1.2 M Long, Self-Adhering, Heat Shrink Edging, PO (Polyolefin), 3.25 mm.

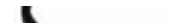

Order Code
769198

ENVIROFLEX RG58 COAXIAL CABLE



Enviroflex_B58 basic cable enables users to quickly switch from fluorine/PVC-containing cables to halogen-free alternatives. The materials used in the cable design both for the dielectric and for the jacket does not include any halogens.



Order Code
2817364

METAL CONTENT CABLE TIE (MCT)



Cable Tie, Nylon 6.6 (Polyamide 6.6), Blue, 150 mm, 3.5 mm, 35 mm, 30 lb.



Order Code
1503047

HA67 HEAT SHRINK TUBING



Adhesive Lined Heat Shrink Tubing, Heavy Wall, 6:1, 0.748", 19 mm, Black, 4 ft, 1.22 m.



Order Code
1729401

TRIM TRIO® WATERPROOF CONNECTORS



The UTG61412PN from Souriau is a plastic circular cable plug connector housing with 12 pin contacts. This connector has shell size of 14. UTG series connectors are economical lightweight and have robust metal locking system.



Order Code
105320

900 SERIES BUCCANEER



The PXA911/07/P from Bulgin is a Buccaneer 7 Pole flex cable connector plug.



Order Code
3844596

CPC SERIES 1



Rugged, cost-effective connectors that can be used to provide power input and output to and from virtually any device. The use of CPC cable assemblies enable customers to reduce installation time, meet harsh and space-saving requirements.



Order Code
592882

M12 SENSOR CONNECTORS



Connector System for machine industrial automation and control applications provide a solution for the increasing need for sensor connections that safely and reliably ensures the communication in industrial environments.



Order Code
2627771

APD SERIES CONNECTORS



The APD-1BS-K2 is a 4-way high-power Plug with silver-plated copper-alloy contacts. This APD series plug has a PBT housing and a PA 66 coupling nut.



Order Code
2059907

CAPLOCK & PLUGLOCK LOCKING ACCESSORIES FOR 38999, RJFTV, USBTV CONNECTORS AND CAPS



CapLock is a locking ring that allows a Cap to lock onto a receptacle to secure the port access. PlugLock is a locking ring that allows a plug to lock onto a receptacle to secure the plug to receptacle connection.



Order Code
3994191

M12 PUSH-PULL CONNECTORS



The SACC-M12MS-8CON-PG9-M is a 8-position straight M12 Plug-In Connector with Au plated CuZn contact, PA carrier contact and grip body, zinc die-cast/nickel-plated knurls and NBR sealing. Flexible connectors for on-site assembly.



Order Code
2308659

NANO-CHANGE SERIES CONNECTORS



The N03MA03124 is a 3-pole straight male Field Attachable Connector with gold-plated brass contacts. The Nano-Change® (M8) industry-standard connector is rugged, space-saving and sealed connector for miniature sensors and actuators in industrial control applications.



Order Code
1606734

MATE N LOK SOCKET CRIMP



926895-1 is a universal MATE-N-LOK series socket contact. This contact base material is brass with tin plating and suitable for crimp termination.



Order Code
285407

DT SERIES AUTOMOTIVE



DT series receptacle connector designed for cable to cable and cable to board applications. The DT connector is used in harsh environment applications where even a small degradation in connection may be critical.



Order Code
2564102

MINIFIT CRIMP



39-00-0078 is a Mini-Fit female crimp terminal with tin (Sn) over copper (Cu) plated brass. It mates with Mini-Fit Jr. receptacle housing 5557, Mini-Fit BMI slide and lock panel mount 44516, Mini-Fit BMI panel mount receptacle housing 42474, 43760. Suitable for power, wire-to-board, wire-to-wire applications.



Order Code
2725176

MICROFIT HEADER



43045-1000 is a 43045 series Micro-Fit 3.0mm connector system. Typical applications are consumer, washers and dryers, freezers, gaming machines, printers, refrigerators, scanners, security systems, vending machines, white goods, telecommunications/networking-routers and switches.



Order Code
1012255

MINITEK PWR 5.7



10146997-10000LF is a Minitek@Pwr 5.70mm, right angle through hole header. It is a flexible and comprehensive solution for power application with high current rating up to 23A per contact and wire gauge range from 16 to 12AWG for wire-to-board application.



Order Code
3497405

HAN-MODULAR E SERIES



Han-Modular series of Heavy Duty connector is rated up to 16A and 400V and up to 500 mating cycles with silver plating contacts.



Order Code
2382688

METRI-PACK 650



Aptiv Metri-Pack series of automotive connectors feature sealed contacts with current ratings up to 46A ideal for many automotive and industrial end use applications.



Order Code
2888010

HAN MODULAR COMPACT



Han Modular series of heavy duty connector hood features a side cable entry mounting, die-cast zinc with nickel-plated finish and is for use in -40°C to +125°C temperature range.



Order Code
2475594

MAGNETIC 5A CONNECTORS



The MP magnetic connectors are a fantastic solution if you require a 2-contact connector, Nd-Fe-B magnetic connectors able to withstand at least 5000 mating cycles. Cable connector available as in-line or right angle and comes with 2m 2 core cable.



Order Code
3369709

MINI I/O CONNECTORS



Rectangular connectors that transfer data between devices in industrial applications. Supporting Power over Ethernet (PoE), PoE+ and PoE++ (IEEE802.3at and IEEE802.3bt) and Data rates from 10Mbps up to 10Gbps.



Order Code
3398060

IP67 RJ45 / USB CONNECTORS



For data communication in harsh environments. CONEC has developed USB and RJ45 connectors in plastic, metalized plastic or full metal shells with IP67 protection IP67 for use where dust and spray water occurs.



Order Code
4070147

ERBIC FIELD BUS INTERFACE



Connectors for CAN bus and Profibus systems. High Interference resistance. Compact size. 9-pin 2.54mm pitch D-Sub.



Order Code
4050002

INDUSTRIAL ELECTRICAL CONNECTORS

A comprehensive range of CEE Connectors available in IP44 & IP67 variants. Ruggedised Male & female options in 3, 4, & 5 poles. Complies to CEE/IEC 60309-1/60309-2. Suited to many applications including, Industrial, Factory & Warehousing, Machinery, Workshops plus many more.

Order Code
4145221



IP67 MP-Y13 / MP-Y21 BAYONET POWER CONNECTORS

A robust range of connectors incorporating bayonet couplings for quick and easy connection/disconnection. Panel mount, cable mount and in-line cable mount options allow versatility. The MP-Y13 series offers up to 13A / 250V and MP-Y21 series up to 30A / 500V.

Order Code
3369849



BRAD INDUSTRIAL ETHERNET CONNECTORS

Bayonet Style and threaded RJ-45 connectors designed to Ethernet specifications. Provides reliable connectivity in harsh industrial automation environments.

Order Code
2612381



MACHINED MICRO-D SPACE SAVING CONNECTOR TECHNOLOGY

Machined Micro-Miniature Interconnect for Cables, Boards and Panels Hand Held & Portable Devices, Wireless Base Stations, Military Telematics, DC/DC Power Supplies, Test & Measurement, Industrial Robotics.

Order Code
3651974



WATERPROOF IP67 USB TYPE C CONNECTOR

6 contact USB charging connector. For IP67 performance sealing gasket can be ordered separately or in a bundle with connector (USB4715-GF-A-KIT).

Order Code
4046871



HEAVY DUTY CONNECTORS

A full range of heavy-duty inserts, housings, crimps and accessories. These connectors have been created for applications that are subjected to harsh environments or where high vibration can cause standard connectors to fail. Ideal for food & beverage manufacturing, packaging machines, conveyor belt systems, railway, oil & gas.

Order Code
3957705



IP67 M12 PUSH-PULL CONNECTORS

The MP M12 push-pull connectors are a range of chrome-plated brass connectors that are both solid enough to be used within tough environments whilst also being aesthetically pleasing. 12mm panel cutout size, push-pull coupling, 2-9 poles, rated up to 13A / 250V, minimum of 500 mating cycles.

Order Code
3369971



IX INDUSTRIAL® ETHERNET INTERFACE

Miniaturised alternative to the RJ45 for IIoT and industry 4.0. Smaller and more robust IP20 plug-in connection which can still produce Cat 6A performance for 1/10Gbit/s Ethernet.

Order Code
2932351



SINGLE PAIR ETHERNET IP20 CONNECTORS

Single Pair Ethernet (SPE) connectors for Industrial applications bring direct Ethernet connectivity to peripheral devices like sensors, actuators, and vision system cameras that operate at speeds up to 1Gb/s.

Order Code
3794462



IP68 SEALED RJ45 BUCCANEER CONNECTORS

Dust and waterproof sealing when mated. Screw coupling. Data rate up to 100MHz. Good chemical resistance, flame retardant. High noise immunity and EMI protection.

Order Code
1211517



/ A WORLDWIDE TEAM WITH A LOCAL FOCUS



Headquarters & Offices in Europe

Austria be.farnell.com	Belgium be.farnell.com	Bulgaria bg.farnell.com	Czech Republic cz.farnell.com	Denmark dk.farnell.com
Estonia ee.farnell.com	Finland fi.farnell.com	France fr.farnell.com	Germany de.farnell.com	Greece export.farnell.com
Hungary hu.farnell.com	Ireland ie.farnell.com	Israel il.farnell.com	Italy it.farnell.com	Latvia lv.farnell.com
Lithuania lt.farnell.com	Netherlands nl.farnell.com	Norway no.farnell.com	Poland pl.farnell.com	Portugal pt.farnell.com
Romania ro.farnell.com	Serbia export.farnell.com	Slovak Republic sk.farnell.com	Slovenia si.farnell.com	South Africa export.farnell.com
Spain es.farnell.com	Sweden se.farnell.com	Switzerland ch.farnell.com	Turkey tr.farnell.com	United Kingdom uk.farnell.com

BUILD AND MAINTAIN YOUR INDUSTRIAL CONTROL PANEL FOR 20% LESS*

From the enclosure outside, the components within, and everything else that keeps them operating safely – engineers choose Multicomp Pro.

Developed by our engineers for engineers like you, Multicomp Pro products and components meet the quality standards engineers require and the value they need to build and maintain industrial control panels at a lower cost without sacrificing quality.

- > Cable & Cable Management
- > Tools
- > Outside the Panel
- > Inside the Panel
- > Panels
- > Converters



*Typically 20% less than other brands