



**Newark**  
AN AVNET COMPANY

# SOLUCIONES DE FABRICACIÓN

Potencie su instalación con productos líderes en la industria

PLC  
HDMI  
CONTROLADORES DE MOTOR  
SENSORES  
INTERRUPTORES  
HERRAMIENTAS  
SUMINISTROS DE PRODUCCIÓN

Escanee el código QR para encontrarnos en la web





# NUESTRO EQUIPO POTENCIA SU ÉXITO



## NUESTROS SERVICIOS



**Un distribuidor mundial de electrónica que le brinda soporte local:** en persona, por teléfono o en línea.



**Cotizaciones de requisitos de volumen:** un equipo dedicado a brindarle asistencia para cotizarle el mejor precio posible.



**Abastecimiento fuera del catálogo:** cuando el producto no está disponible en nuestra gama, nuestro equipo puede ayudarle a obtenerlo directamente del fabricante.



**Carga de lista de piezas (BoM manager):** cargue la lista completa de piezas o lista de materiales con nuestra herramienta de carga automatizada (BoM).



**Servicio de notificación de cambios en el producto:** advertencia temprana por correo electrónico sobre cambios de materiales, componentes obsoletos, discontinuados o existencias agotadas.



**Servicios de calibración:** ofrecemos dos niveles de calibración de productos nuevos de pruebas y medición que nos haya comprado.



**Gabinetes personalizados:** ofrecemos modificaciones estándar o personalizaciones completas de gabinetes para que sean compatibles con su diseño.

## SU SOCIO FABRICANTE



Más de **80,000 productos de automatización y control industrial.**



**42 fabricantes líderes** como Festo, Schneider, ABB, Omega, Honeywell.



Nuestro **nuevo centro de control y automatización industrial** ofrece recursos técnicos dedicados para IIoT.



**Guías de soluciones,** documentos técnicos, módulos de capacitación, podcast y más.



Más de **350,000 productos industriales** para todas las necesidades de su fábrica: pruebas, herramientas, equipos de protección personal, productos químicos y más.

# HOLA, LE DAMOS LA BIENVENIDA A NUESTRA EXHIBICIÓN DE SOLUCIONES DE FABRICACIÓN

En Newark, nos entusiasma la Industria 4.0 y las oportunidades relacionadas con IIoT que se ofrecen para potenciar la eficiencia en la fabricación. Reducir el tiempo de inactividad, mejorar la eficiencia energética y la productividad, al mismo tiempo que se reducen los costos, ofrecen beneficios significativos para los fabricantes. Sin embargo, los principios de la Industria 4.0 pueden ser complejos, y saber dónde y cómo empezar es desafiante.

En Newark, trabajamos con algunos de los proveedores más grandes para que los clientes de todos los tamaños puedan aprovechar las ventajas de estos conceptos, y hemos expandido significativamente nuestra gama de productos para que usted pueda impulsar una mejor eficiencia en el proceso de fabricación.

Explore los destacados entre más de **350,000** productos industriales en línea.



**Simon Meadmore**

Vicepresidente, Gestión de productos y proveedores

## ÍNDICE

**05** AUTOMATIZACIÓN Y CONTROL INDUSTRIAL

**09** OPTIMIZACIÓN DE EFICIENCIA ENERGÉTICA

**11** VENTILADORES Y DE VENTILADORES  
ACCESORIOS

**12** VENTILADORES Y GABINETES

**14** FUERZA

**18** RELEVADORES Y FUSIBLES

**20** SENSORES

**22** INTERRUPTORES

**24** PRUEBAS Y MEDICIÓN

**27** SUMINISTROS DE HERRAMIENTAS  
Y PRODUCCIÓN

**31** COMPUTADORAS DE PLACA ÚNICA

**32** CABLES

**33** CONECTORES



Escanee el código QR para  
explorar IAC en línea

# CENTRO DE RECURSOS TÉCNICOS

Aprenda acerca de las innovaciones, manténgase informado, inspírese

Una selección integral de productos clasificada en situaciones de diseño, últimas noticias y tendencias, recursos y herramientas de diseño que le permiten utilizar desde el concepto de diagrama de bloques hasta obtener la solución para las aplicaciones de segmento vertical.



Explore nuestra biblioteca en crecimiento de:



Documentos técnicos



Artículos



Procedimientos



Seminarios web



Pódcast



**CAM POSITIONER, H8PS SERIES, FLUSH MOUNT, PNP TRANSISTOR OUTPUT**



The H8PS8BP is a 8-output flush-mounting Cam Positioner with PNP transistor output. It is popular for its ease-of-use and offers highly visible display with backlit negative transmissive LCD and advance angle compensation function to compensate for output delays.



Order Code  
**38B702**

**PLC, MILLENNIUM 3, CUSTOM COMPACT RANGE, 12 INPUTS, 8 RELAY OUTPUTS, 24 VDC, TYPE CB20**



The 88974031 is a programmable Logic Controller (PLC), an efficient and economical version without display or keys setting. It allows the use of the entire library of specific functions blocs of the software workshop.



Order Code  
**64R1065**

**COMPACT SMART RELAY, 16 I/O, 24V**



Compact smart relays for simple automation systems from 10 to 40 I/Os. The compact smart relay provides a real alternative to solutions based on cabled logic or specific cards. It comes with display and clock.



Order Code  
**24AJ2238**

**CONTROLLER, RELAY, 4 ANALOG I/P, 8 DIGITAL I/P, 4 DIGITAL O/P, 12/24 VDC, EASYE4 SERIES**



EASY-E4-UC-12RCX1 is a easyE4 basic control relay. Expandable with the easyE4 series of digital input/output expansions with easy-E4-CONNECT1 connector.



Order Code  
**52AH6820**

**DIGITAL I/O MODULE**



The easyE4 control relays can be used within many different projects meeting your requirements for a flexible, modular system.



Order Code  
**52AH6813**

**WIRELESS I/O MODULE**



WISE-4610-NA is a LoRaWAN IoT wireless modular I/O. WISE-4610 features a wireless sensor node based on LoRa network technologies targeting outdoor applications. It provide wireless communication coverage of 5 kilometers and has a long battery life.



Order Code  
**81AH0334**

**EASY4 CONTROL RELAY**



Control Relay W/Display, 8 I/P, 4 O/P; No. of Digital Inputs:8; No. of Digital Outputs:4; Product Range:easyE4 Series



Order Code  
**52AH6811**

**EDGE CONTROLLER**



Controller, 2 x ENET/3 x USB/HDMI/CAN/DI/DO; No. of Digital Inputs/Outputs: 4, Product Range: 752 Series



Order Code  
**48AJ8311**

**DIGITAL OUTPUT MODULE**



DIGITAL OUTPUT MOD, 8O/P, RELAY, 2A/250V; IP / NEMA Rating:IP20; Supply Voltage:- No. of Digital Outputs:8; Product Range:NX Series



Order Code  
**78AC3599**

**DIGITAL OUTPUT MODULE**



Digital output modules are available in the following variants: 4 DO, 8 DO with 2- and 3-wire technology, 16 DO with or without PLC interface connection. They are mainly used for the incorporation of decentralized actuators.



Order Code  
**95Y6643**

**PROGRAMMABLE RELAY, ZEN SERIES, STANDARD, 6 INPUTS, 4 RELAY OUTPUTS, 12 TO 24 VDC, LCD DISPLAY**



The ZEN-10C1DR-D-V2 is a Programmable Relay with increased functionality and higher precision. This single CPU unit easily provides relay, timer, counter and time switch functions.



Order Code  
**22M4073**

**CPU MODULE PLC**



The FL1F-H12RCA is a 6th-generation SmartRelay CPU Base Module that offers functions to give you even more flexibility and convenience. Advances include extended memory, a brighter display improved analogue and high-speed inputs, an external text display and upgraded programming software.



Order Code  
**72Y0238**

**EIO DROP ADAPTOR, WITH ETHERNET BACKPLANE, 3 PORT, IP20, MODICON X80 SERIES**



Modicon X80 range, a common platform of modules for Modicon M580 and M340 Programmable Automation Controllers (PAC). This Ethernet Remote Input Output (RIO) drop adaptor has 3 ports with Ethernet backplane.



Order Code  
**73Y6791**

**INDUSTRIAL IOT 4G LTE ROUTER & GATEWAY**



The ICR-3200 LTE gateway is the perfect way to connect IP or serial devices to a cellular network. Industrial M2M and IoT applications include kiosks, industrial PCs, HMIs, traffic controllers, meters, UPS systems, and much more.



Order Code  
**52AH6899**

**INDUSTRIAL IOT ROUTER AND GATEWAY**



The ICR-3200 4G LTE gateway is the perfect way to connect IP or serial devices via a cellular network. Industrial M2M and IoT applications include SCADA, industrial PCs, HMIs, traffic controllers, CCTV, meters, kiosks, UPS systems, and much more.



Order Code  
**77AK4359**

**INDUSTRIAL LORAWAN GATEWAY**



The WISE-6610 is a high-performance LoRaWAN gateway that offers reliable connectivity for industrial environments. It supports the LoRaWAN protocol for building LoRaWAN private and public networks, as well as various protocols including MQTT. T



Order Code  
**54AH9768**

**SWITCH, 5 PORTS, INDUSTRIAL, UNMANAGED FAST ETHERNET, DIN RAIL, RJ45 X 5, 10MBPS, 100MBPS**



1240840000 from Weidmuller is a fast Ethernet switch with 5 RJ45ports. This rugged hardware design is well suited for hazardous locations (Class I Div. 2 /ATEX) and maritime environments (DNV/GL).



Order Code  
**44T5715**

**SWITCH, 4 PORTS, INDUSTRIAL, MANAGED FAST ETHERNET, DIN RAIL, RJ45 X 1, 10MBPS, 100MBPS**



The GECKO 4TX is an industrial Ethernet Switch ideally suited for use in smaller networks or on the edge of larger installations. The device guarantees reliable data communication and enhanced redundancy and diagnostic features.



Order Code  
**75X8161**

**NEON INDICATOR, ORG, RECTANGULAR, 250VAC ROHS COMPLIANT: YES**



To maintain design continuity, these switch sizes, panel mounts, and indicators can be installed next to switches on a panel. Ideal for many uses, including as control panels, office equipment, and HVAC systems.



Order Code  
**85AJ3426**

**LIQUID LEVEL CONTROLLERS**



Fully automatic operation enables both draining and filling simultaneously with a single device. Adjustable sensitivity level from 1k to 200k Ohm, 110VAC, 240VAC & 400VAC supply voltage options.



Order Code  
**69AK8673**

**MULTIHOP ETHERNET DATA RADIO**



DX80ER9M-H is a Sure Cross® MultiHop Ethernet data radio wireless industrial communication device used to create point to multipoint configurations of wireless Ethernet networks. It provides extremely reliable communication in large plants, over long distances, or through difficult terrain.



Order Code  
**75X9215**

**SWITCH, 8 PORTS, INDUSTRIAL, UNMANAGED GIGABIT ETHERNET, DIN RAIL, RJ45 X 8**



Unmanaged industrial Ethernet switches provide a full Gigabit Ethernet non-blocking switch with 8 ports, a nominal voltage of 24, 48 volts, and an operating temperature range of -40 to +70 degrees Celsius.



Order Code  
**36AJ7010**

**SWITCH, 8 PORTS, INDUSTRIAL, ETHERNET, DIN RAIL, RJ45 X 8, 10MBPS, 100MBPS, 1GBPS**



This unmanaged industrial ETHERNET switch (852-1112) has 8 Gigabit ETHERNET ports for easily setting up small- to medium-sized networks. Its slim design paired with a DIN-rail adapter simplifies installation in the control cabinet and provides high vibration and shock resistance.



Order Code  
**08AC2192**

**NEON INDICATOR, ORANGE, 10MM, DOME, 250V ROHS COMPLIANT: YES**



Panel Indicator Lights – indicator lights are an important visual component on many applications. These are 250V neon indicators, available in red, green or amber, with 10mm cut-out.



Order Code  
**85AJ3429**

**IPS TFT DISPLAYS – SCREEN SIZES FROM 4.3" TO 15.6"**



These next-generation of IPS TFT HDMI Displays offer a simple & fast method to integrate a display into your product via an LVDS conversion module on board. Ideal for use with Raspberry Pi, UP or iBASE computers.



Order Code  
**59AK7440**

**DEVICE SERVER, ETHERNET TO SERIAL, 4 PORT, RS-232, 230400 BAUD RATE**



A web interface allows secure configuration and control of the serial ports over a local network or the internet using any browser. For Windows our in-house designed (32 bit and 64 bit) driver gives you local COM ports.



Order Code  
**92T1122**

**THERMOSTAT**



The mechanical thermostats KTO 111 and KTS 111 are two state regulators for use up to 5,000 meters in altitude, thanks to optimized air gap and increased creepage distance. By use of Push-In terminals the thermostat is wired tool-free.



Order Code  
**24AJ5671**

**DIGITAL TIME SWITCHES**



Precise time programming for astro / daily / weekly / pulse switching, 16A single and dual relay outputs, 12/24 hour display format, 6 years battery reserve



Order Code  
**69AK8651**

**PTC THERMISTOR RELAYS – MP-225**



Uses integrated PTC resistors to monitor and protect Motors against over heating under heavy duty load, high switching frequencies and high operating temperatures & insufficient cooling conditions.



Order Code  
**69AK8668**

**OPEN FRAME TFT DISPLAYS**



Choice of 7", 10.1", 10.4" and 12.1" active displays within a metal frame that are ideal for use with SBCs, as an HMI or with any device which has a HDMI output. The displays have projected capacitive touch, HDMI interface, automatic dimming and support Rear or VESA mounting.



Order Code  
**69AK8708**



**MOTOR STARTER, MANUAL, 3 POLE, 4A, 690 VAC, IP20/IK04**

Life Is On | Schneider Electric

GP2E08 is a 3-pole (3P), 4A/690V, for 3-phase motor applications 1.1-1.5kW@400V. It provides thermal-magnetic protection with a thermal setting range of 2.5-4A, magnetic tripping at 13xIn, and a high breaking capacity Icu 100kA@400V.



Order Code  
**43AJ7142**

**INVERTER DRIVE, MICRO, 3-PH, 1.5KW**



The ACS150 drives can be integrated into a broad range of devices, including pumps, fans, mixers and conveyors. Drive selection and setting are made simple by the ACS150 drives' integrated user panel, potentiometer, and numerous other features, like pre-defined connection macros.



Order Code  
**97Y9098**

**TESYS U STANDARD CONTROL UNIT**

Life Is On | Schneider Electric

The LUCA05BL is a 3-phase 5A plug-in front side mounting standard Control Unit for use in overload and short-circuit basic protection requirements of motor starters. It is compatible with the ASILUFC5, ASILUFC51, LUFC00, LUFN, LULC031, LULC033, LULC07, LULC08, LULC09 and LULC15 communication modules.



Order Code  
**89H5223**

**MOTOR CONTROLLER**



Motor Controller, BLDC, 5A, 24-48VDC; Control/Drive Type: Motor/Speed Controller Compatible Motor Type: Brushless DC Motors; Output Current Max: 5A; Supply Voltage Min: 24VDC; Supply Voltage Max: 48VDC



Order Code  
**42AJ7872**

**DC MOTOR**



EC 45 flat Ø42.8 mm, brushless, 50 Watt



Order Code  
**15R2903**

**STEPPER MOTOR**



The 4118M-01R0 is a 1.58" bipolar torque Steeper Motor for high and low speed applications.

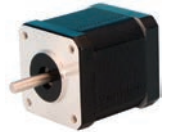

Order Code  
**16M4197**

**PNEUMATIC FLOW CONTROL**



Legris pressure regulator fittings are used to stabilize at a given value the pressure applied to pneumatic equipment, whatever the fluctuations of pressure upstream.



Order Code  
**35M2246**

**PNEUMATIC VALVE CONTROL**



The 81921701 is a miniature pneumatic Position Detector and control by lever with plastic roller. It is made of Zamak body material and 8bar maximum operating pressure.



Order Code  
**34B3827**

**PNEUMATIC SWITCH**



The 81502160 is a 30 to 120psi monostable Adjustable Pressure Switch with negative output (NO).



Order Code  
**34B3499**

**AIR COMPRESSOR SWITCH**



Air Compressor Switch, DPST-NC, 200PSI; Contact Configuration: DPST; Switch Terminals: Screw; Product Range: 9013FHG Series.



Order Code  
**64M4545**

**HMI TOUCH SCREEN, 4.3", TFT LCD, 24VDC**

Life Is On | Schneider Electric

The HMIST0735 is a compact touchscreen operator interface (HMI) with a 4.3" color TFT LCD display with 480 x 272 pixels and 26MB EPROM. It is powered by 12V to 24V DC.



Order Code  
**66AH6149**

**MULTICOMP PRO ASM-1900156-11 DEVELOPMENT BOARD ENCLOSURE, RASPBERRY PI 4 MODEL B**



Raspberry Pi 4 white colour case assembly is a high quality ABS case designed specifically for the Raspberry Pi 4 Model B and the official touchscreen to be used as a single unit.



Order Code  
**07AH2046**

**TEMPERATURE CONTROLLER**



The TC4H-24R from Autonics is a 4-digit single display economical PID Temperature Controller. The TC series is one of the most temperature controlling solution with essential functions and improved performance



Order Code  
**22T3613**

**TEMPERATURE CONTROLLER**



The E5CC-RX3A5M-000 is a digital temperature controller. The controller will save time and effort in set-up and operation, while enabling faster and more accurate monitoring/control of process.



Order Code  
**05W3885**

**ANALOG PANEL METER**



The PM-50 meters are designed to increase operator productivity, expose critical plant floor data, and aid in project scheduling and process improvements. Easily relatable intuitive graphical display. Secondary displays provide even more data.



Order Code  
**72AJ5676**

**HMI TOUCH SCREEN, 1280 X 1024P, 17"**



The Advantech TPC-1751T(B) thin-client terminal delivers high-performance computing in a compact, fanless system, thanks to its 17" XGA TFT LED LCD, low-power Intel® Atom™ E3845, 1.91GHz quad-core processor, and 4 GB of DDR3L SDRAM.



Order Code  
**73AH9561**

**SMART GRAPHICS DISPLAY**



The OM-SGD Series is a family of panel meters with smart graphics display. The configuration software is compatible with Windows® XP (SP3), Vista, 7 and 8 and can be downloaded free online at OMEGA.

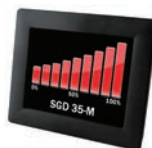

Order Code  
**39AH7190**

**H3CA SERIES TIMER**



The CX202A6 is a Microprocessor Timer with 199.99 seconds to 199.98 hours delay. Supports On-delay/standard start, OFF-delay/reverse start, interval/one-shot, asymmetrical repeat cycle. Timer is housed in a standard 15 terminal CYCL-FLEX® plug-in case.



Order Code  
**01B2134**

**TIMER**



The LT4HW-AC240VS is a Digital Twin Timer with screw terminals, individual setting can be performed on each of 1 and 2 timers. This timer works in 3 operating modes and has a brand new bright 2-color back light LCD display.



Order Code  
**53M8175**

**CURRENT SHUNT, DC AMMETER, 10 A, 0.25 %, -20 °C, 60 °C, FN SERIES**



The FN-10-50 is a Switchboard Shunt with extending measurement of currents beyond available limits of self-contained DC ammeters. It is recommended that shunt will not run at more than two-thirds (2/3) the rated current under normal conditions as per IEEE standards.



Order Code  
**93B9571**

**DIGITAL TIME SWITCHES**



Digital (analogue-style) time switch, daily/weekly programming can be programmed in "Classic" mode via the joystick, or "Smart" mode via smartphones with NFC communication, they have minimum time interval setting - 30 minutes and are easily configurable for daily or weekly programming.



Order Code  
**10AC9866**

**POWER ANALYZER METER**



The WM20AV53H from Cargo Gavazzi is a power analyzer. It is a modular power analyzer for single, two and three phase systems. This power analyzer is made up of a main unit that displays measurements on LCD displays, digital output module and communication module.



Order Code  
**14AC1831**

**POWER METER**



APM-PWR-APO is a APM power meter for single-, split- and 3-phase applications. It measures active (W), reactive (VAR) and apparent (VA) power. User-programmable scale and custom alarm messages display critical parameters and immediately alerts operators when a parameter is out of range.



Order Code  
**40AH1874**

**COUNTER**



The CUB4L020 is a Miniature Electronic Counter with red backlight display. It has a lightweight, high impact plastic case with a clear viewing window. The sealed front panel with the silicone rubber reset button meets NEMA 4X/IP65 specifications for wash-down and/or dusty environments, when properly installed.



Order Code  
**46M3293**

**SAFETY LIGHT CURTAIN**



MINI-ARRAY BASIC Two-Piece Measuring Light Curtain configured for material handling and logistics applications with auto-stream serial output, two discrete outputs, and EIA-485 communication.



Order Code  
**08AK8953**

**PART SENSING LIGHT SCREEN**



The LX3RQ emitter and receiver pair produce a strobed web of modulated light beams in 12 lengths and two sensing ranges. Simple, economical and highly reliable means of sensing small parts or flat items which pass anywhere through the light screen.



Order Code  
**99H0171**

**ISOLATED SWITCH SIGNAL CONDITIONER**



The KFA5-SR2-EX2.W is a 2-channel isolated barrier Switch Amplifier used for intrinsic safety applications. It transfers digital signals (NAMUR sensors/mechanical contacts) from a hazardous area to a safe area. The proximity sensor or switch controls a form-C changeover relay contact for the safe area load.



Order Code  
**73C5818**

**SIGNALING CONDITIONER SWITCH AMPLIFIER**



The IM1-22EX-T is a 2-channel Isolating Switching Amplifier equipped with intrinsically safe input circuits. The sensors according to EN 60947-5-6 or potential-free contact transmitters can be connected to the device. The output circuits feature 2 potential-free and short-circuit proof transistors.



Order Code  
**37R2187**

**ANALOG TIMER**



The GT5Y-4SN1A100 is an ON-delay SPDT Analog Timer with plug-in termination and 4-changeover relay. The GT5Y series timer uses the same sockets and hold-down clips as IDECs RY4S and RU series relays, 4 time ranges, power ON and timing out LED indicators and control settings by hand or screwdriver.



Order Code  
**66F4213**

**PRESSURE GAUGE**



DPG108 is a battery powered digital pressure gauge, making for easy on-site installation. The DPG108 uses a high-precision piezo-resistive pressure sensor.



Order Code  
**32AH9141**



# HOW TO OPTIMISE ENERGY EFFICIENCY IN FACTORY PRODUCTION SYSTEMS?

Electric motors are the main power units behind almost all automation devices in production plants. Over 40 percent of generated electricity is consumed by industry and two-thirds of energy is used by electric motors. Losses are an inevitable part of running a motor and they directly affect efficiency. Losses are minimised by using higher cutting edge motor designs, proper motor control selection, and considering the torque of the motor in high-precision automated production systems.



Figure 1 describes the main elements in an automated machine or process found in a modern factory. The efficiency of the motors and the whole production process is determined by multiple control layers. The first control layer adjusts the power inverter switching sequence to manage the motor voltage and current and enhance torque production efficiency.

Next is the position and speed controller that operates the machine efficiently. In process equipment, this could be a sequence of speed or position orders to perform an assembly function, whereas, in automation equipment, this could be a sequence of speed or position commands to execute an assembly function.

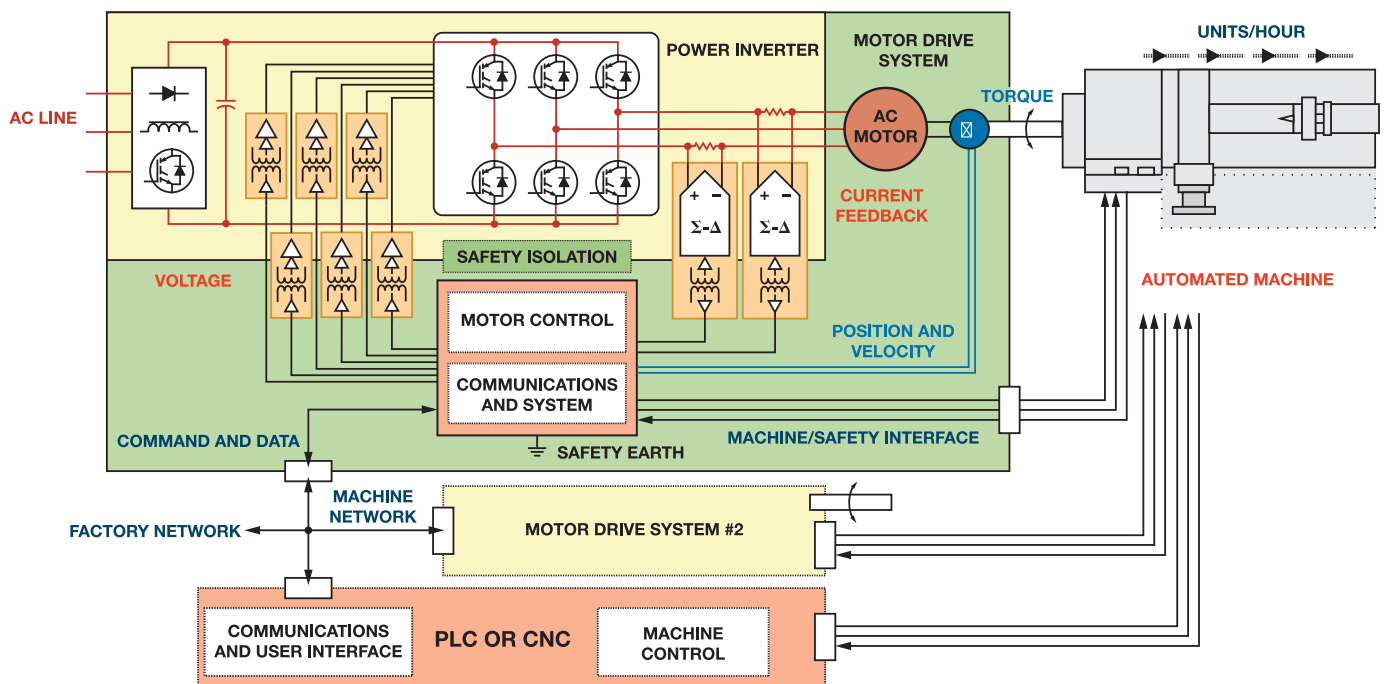

Figure 1: Block diagram of automated machine control system

In the latter scenario, the response time of the speed control will be more critical to the machine controller than torque production efficiency. As multiple motors are now synchronised across high-speed data networks that are also connected to the factory network, the communications and systems layer is becoming increasingly important.

The torque produced per amp supplied at any given speed and terminal voltage influences motor efficiency. Torque is generated by forces that tend to align their internal magnetic fields. When the stator currents are synchronised with the rotor motion to maintain continuous field misalignment, AC motors produce constant torque. The frequency of the motor currents is closely connected to the ac motor speed, therefore speed regulation necessitates the use of a variable frequency voltage source, such as VSDs or

When the rotor-stator field misalignment is at its maximum, the efficiency is maximum. Motor efficiency also depends upon motor construction and particularly the rotor field structure. Permanent magnet synchronous motors (PMSM) are more efficient, since no current is required to magnetise the rotor field. Because of their prominent magnetic core construction, ultrahigh efficiency interior permanent magnet (IPM) motors generate additional torque.

### Using soft starters in AC induction motors:

When starting, the AC Induction motor develops more torque than is required at full speed. This stress is transferred to the mechanical transmission system, causing excessive wear and premature failure of chains, belts, gears, mechanical seals, and other components. Rapid acceleration also has a significant influence on electricity supply charges, with high inrush currents drawing +600% of the normal run current. The use of Star Delta only provides a partial solution to the problem. If the motor slows down during the transition time, the high peaks will be repeated and may potentially exceed direct on line current. provide a reliable and economical solution to these issues by delivering a controlled release of power to the motor, resulting in smooth, step-less acceleration and deceleration, as illustrated in Figure 2.

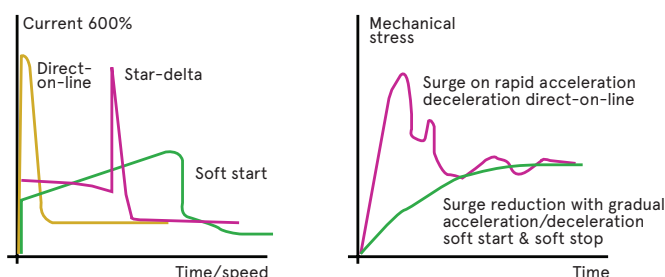

Figure 2: Performance curve as compared to direct-on line, Star-delta and Soft Start

As damage to windings and bearings is reduced, motor life will be extended. Soft Start & Soft Stop is incorporated into three-phase systems, allowing for regulated starting and stopping with a selection of ramp times and current limit settings.

### By adopting predictive and condition monitoring:

Condition Monitoring (CM) is the monitoring of several parameters such as equipment vibration and temperature to identify potential concerns such as misalignments or bearing failures. When a vibration analysis reveals a change in the harmonic frequency of rotating equipment components, condition monitoring tools can map equipment degradation.

Frequency analysis can be performed using both vibrometer and microphone data. Continuous Predictive and Condition Monitoring techniques might be used on a range of equipment, including compressors, pumps, spindles, and motors, and they can also be used to detect partial discharge on machines or vacuum leaks. This analysis helps factories to maximise efficiency and equipment availability whilst lowering costs.

### Improving efficient motion control with precision isolation and effective communications:

The combination of precision in motion control and communication timing enables shorter machine production cycles and reduces the amount of energy consumed to manufacture each part. PMSM service motors and drives designed for fast response and high precision in speed and position control are used by drive manufacturers to assist automation applications.

The use of high-speed magnetic isolation technology allows for the safe isolation of analog and digital signal voltages without sacrificing speed or precision. Precision integrated into the encoder position offer position feedback with up to a 24-bit resolution, enabling high dynamic velocity control at rates as low as 1 RPM.

This level of performance is appropriate for automation applications such as multiaxis milling of precision machine parts, assembly of fine geometry integrated circuits, and injection molding of cell phone parts. Furthermore, to ensure control precision, the motors' motion timing should be perfectly synchronised, because a timing error directly translates into a trajectory error in multiaxis position control.

Industrial Ethernet protocols, such as and , use modified Ethernet network interfaces to support real-time data synchronisation with clock jitter as low as 1µs. These network interfaces support both synchronised motion control and factory network connectivity for production system management.



**4600N - AC AXIAL FAN**



AXIAL FAN, 119MM x 119MM x 38MM, 115VAC; Nominal Rated Voltage AC:115V; Fan Frame Type:Square; Fan Frame Size:119mm; External Depth:38mm; Bearing Type:Sleeve Bearing; Air Flow - CFM:105.9CFM; Noise Rating:50dBA; Power Rating:18W



Order Code  
**86K9858**

**W2E250-HL06-01 - AC AXIAL FAN**



The W2E250-HL06-01 is a 230VAC Axial Fan with a wall ring, ball bearing, terminal power connection and 1-phase 2-pole motor with operating capacitor. Sheet steel, coated in black impeller, die-cast aluminum wall ring, variable cable exit.



Order Code  
**11J4700**

**AHC110E, CORROSION INHIBITOR EMITTER**



Corrosion Inhibitor, Enclosure; Coating Type: Corrosion Protection; Coating Applications: Electrical Enclosures, Boxes, Consoles and Wireways; Dispensing Method: Capsule



Order Code  
**06B4646**

**ADSV2536BK, RACK SHELF**



SHELF, ADJ, STEEL, 1U, 25" X 19", BLACK; Rack U Height:1U; External Width - Metric:483mm; External Depth - Metric:914.4mm; For Use With:Hammond Racks & Rack Cabinets; External Width - Imperial:19"; External Depth - Imperial:36"



Order Code  
**58Y6780**

**3231, METAL ENCLOSURE**



BOX, SHIELDED, ALUMINIUM, BLUE; Enclosure Type:Multipurpose; Enclosure Material:Aluminum; External Height - Metric:35.05mm; External Width - Metric:57mm; External Depth - Metric:29mm; Body Color:Blue; External Height - Imperial:1.38"



Order Code  
**35F3504**

**RER125-19/14N - FAN BLOWER**



The RER125DC series compact DC Centrifugal Fan for electronics cooling with unbeatable high-pressure specialists in centrifugal design with 90° air deflection and carefully optimized impellers. Ideally match for highly compact 1U and 2U rack-mount servers.



Order Code  
**86K9748**

**OD3010-12HB01A - DC AXIAL FAN**



OD3010 Series, DC Fan - 5V, 12V, Square. Frame and impeller: PBT, UL94V-O plastic, Connection: 2x Lead wires 28AWG, Motor: Brushless DC, auto restart, impedance and polarity protected.



Order Code  
**89AH2547**

**R2E220-AA40-23, FAN BLOWER**



AC Motorized Impeller, 220MM x 63MM, 230VAC; Blower Type: Motorized Impeller; Supply Voltage: 230VAC; Voltage Type: AC; Fan Frame Size: 220mm; External Depth: 63mm; Air Flow - CFM:530CFM; Air Flow - m3/min: 14.84m3/min; Noise Rating: 74dBA



Order Code  
**86K9785**

**5214NH - DC AXIAL FAN**



The 5214NH is a 24VDC standard or basic high speed Axial Fan with speed signal, ball bearing and wire leaded power connection. Fibreglass-reinforced plastic (PBT) housing and fibreglass-reinforced plastic (PA) impeller.



Order Code  
**86K9872**

**B-308, MOUNTING BRACKET**



MOUNTING BRACKET, C-300 SLIDES, STEEL; Enclosure Material:Steel; External Height - Metric:44.2mm; External Width - Metric:184mm; For Use With:C-300 Series Slides; External Height - Imperial:1.74"; External Width - Imperial:7.3"



Order Code  
**51F4073**

**A2D250-AA06-71 - AC AXIAL FAN**



A2D250-AA06-71 AC Axial Fan, 230V / 400V, Circular, 250 mm, 82.5 mm, Ball Bearing



Order Code  
**02E9010**

**D-329, CABLE ORGANIZER**



CABLE CARRIER, STEEL, CLEAR; Cable Organizer Type:Two Point Mount Cable Carrier; Product Range:D-329 Series Cable Carrier; Colour:Clear Zinc Plating; External Height:30"; External Width:1.5"; Material:Steel



Order Code  
**51F4102**

**4600X, AC AXIAL FAN**



AXIAL FAN, 119MM x 119MM x 38MM, 115VAC; Nominal Rated Voltage AC:115V; Fan Frame Type:Square; Fan Frame Size:119mm; External Depth:38mm; Bearing Type:Sleeve Bearing; Air Flow - CFM:106CFM; Noise Rating:50dBA; Power Rating:18W



Order Code  
**88K2738**

**ASB0305LA-DR00 DC AXIAL FAN**



5 V, Square, 30 mm, 10 mm, Sleeve Bearing, 3.21 CFM



Order Code  
**70AH3056**

**4300 SERIES**



DC Axial Fan, 48 V, Square, 119 mm, 32 mm, Ball Bearing, 100.1 CFM



Order Code  
**86K9852**

**2406KL-05W-B59-L50, DC AXIAL FAN,**



DC FAN, AXIAL, 60MM X 60MM X 15MM, 24V; Supply Voltage VDC:24V; Fan Frame Type:Square; Fan Frame Size:60mm; External Depth:15mm; Bearing Type:Ball Bearing; Air Flow - CFM:18.3CFM; Noise Rating:34dBA; Power Rating:2.4W.



Order Code  
**27M3349**

**34561-484, THREADED INSERT**



THREADED STRIP, M3, 84HP, 431.3MM, STEEL; Accessory Type:Threaded Insert; For Use With:Horizontal Rails; Product Range:EuropacPRO, PropacPRO, CompacPRO and RatiopacPRO Series



Order Code  
**64T9880**

**AD1224UB-F51, DC AXIAL FAN**



AXIAL FAN, 120MM x 120MM x 38MM, 24VDC, 380MA; Supply Voltage VDC:24V; Fan Frame Type:Square; Fan Frame Size:120mm; External Depth:38mm; Bearing Type:Ball Bearing; Air Flow - CFM:120.109CFM; Noise Rating:48dBA; Power Rating:9.12W



Order Code  
**58P0883**

**ASB0412LA-A - DC AXIAL FAN**



12 V, Square, 40 mm, 10 mm, Sleeve Bearing, 4.394 CFM



Order Code  
**77AH7294**

**BNDN1000, DIN MOUNTING RAIL**



DIN MOUNTING RAIL, 35MM, ALUMINIUM; Accessory Type:DIN Mounting Rail; For Use With:BNH/BN Series Terminal Blocks; Length:1m; Height:10.5mm; Width:35mm; Rail Material:Aluminium; Fixing Centers:51mm.



Order Code  
**96F6501**

**DAH1001A, ELECTRIC HEATER**



ELECTRIC HEATER, 100W, 0+F-100+F, 115V; Voltage Rating VAC:115V; Output Power:100W; External Height - Metric:139.7mm; External Width - Metric:102mm; External Depth - Metric:122mm; External Height - Imperial:5.5".



Order Code  
**19M8419**

**A6AXFN, AC AXIAL FAN**



AXIAL FAN, 149MM x 162MM x 38MM, 115VAC, 360MA; Nominal Rated Voltage AC:115V; Fan Frame Type:Square; Fan Frame Size:172mm; External Depth:38mm; Bearing Type:Ball Bearing; Air Flow - CFM:240CFM; Noise Rating:56dBA; Power Rating:32W



Order Code  
**92F089**

**ATEM SERIES**



Thermostat, 120 VAC, 15 A, NC, -49 °F, 176 °F, ATEM Series



Order Code  
**90AJ4544**

**EFB0512LA - DC AXIAL FAN,**



DC Axial Fan, 12 V, Square, 50 mm, 10 mm, Ball Bearing, 7.5 CFM



Order Code  
**EFB0512LA**

**R2E220-AB08-12, FAN BLOWER**



AC MOTORIZED IMPELLER, 220MM x 63MM, 115VAC; Blower Type:Motorized Impeller; Supply Voltage:115VAC; Voltage Type:AC; Fan Frame Size:220mm; External Depth:73mm; Air Flow - CFM:629.5CFM; Air Flow - m3/min:17.825m<sup>3</sup>/min.



Order Code  
**75C9660**

**RM-14212, 19" CASE**



CHASSIS, RACK MOUNT, 4.281IN, ALUMINIUM; Rack U Height:3U; Enclosure Material:Aluminum; Cabinet Style:Rack Mount; External Height - Metric:133.4mm; External Width - Metric:483mm; External Depth - Metric:437mm; Body Color:Unfinished

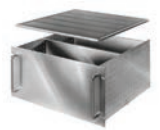

Order Code  
**06M4780**

**ASB0412VHA-AF00 - DC AXIAL FAN**



12 V, Square, 40 mm, 10 mm, Sleeve Bearing, 9.505 CFM



Order Code  
**77AH7296**

**C-300-S-124, SLIDE**



TELESCOPING SLIDE, 25IN, STEEL; Length:24"; Extended Length:25"; Bearing Style:Solid; Carrying Capacity:85lb; Product Range:C-300 Series Solid Bearing Slide; External Depth:0.49"



Order Code  
**93B6957**

**CWB-15101, MOUNTING BRACKET**



WALL BRACKET, METAL CORNER, 13"X3"X2.7"; Enclosure Material:Galvanized Steel; External Height - Metric:68.88mm; External Width - Metric:76.2mm; For Use With:BUD Industries 3" to 14" Plastic Enclosures; External Height - Imperial:2.7"

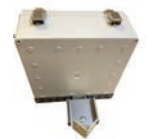

Order Code  
**34AK3832**

**4600N-466, AC AXIAL FAN**



FAN, AXIAL, 119MM, 115VAC; Nominal Rated Voltage AC:115V; Fan Frame Type:Square; Fan Frame Size:119mm; External Depth:38mm; Bearing Type:Sleeve Bearing; Air Flow - CFM:105.9CFM; Noise Rating:50dBA; Power Rating:18W.



Order Code  
**03P9511**





# Standard Power Solutions

## Modular Power



NMP Series



: The premium series



: The best cost-performance series



## Enclosed Type



LRS/SE/RS/  
RD/RT/RQ Series



HRP-N3 Series



UHP Series



HEP Series



RSP/RST/SHP Series



## DIN Rail Type



MDR Series



HDR Series



SDR/NDR/EDR  
WDR//TDR Series



DRS Series



DRC Series



## PCB Type



EPS/EPP/  
PSC Series



IRM/MPM/  
MFM Series

## Smart Controller



CMU2 Series

## System Power



Dxx-3200 Series



## DC/DC Converter

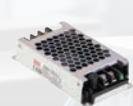

RSD Series



DDR/DDRH Series



NSD/NID Series



Module Type

## Green Adaptor



GST/GSM/  
GEM/SGA Series



## Charger & Inverter



NPB/NPP Series



RPB/RCB Series



ENC Series



GC Series



NTS/NTU Series



**RECHARGEABLE BATTERY, 48 V, CONNECTOR**

The RBC94-2U is a 48VDC 2U UPS replacement Rechargeable Battery Cartridge for select Tripp Lite SmartPro UPS. The battery cartridges breathe new life into UPS systems suffering from expired or weak internal batteries.



Order Code  
**06M3056**

**EV PEDESTAL, SINGLE PORT, WALL CHARGER**

Recharge your electric vehicle faster and cost effectively with Eaton Green Motion EV single port pedestal charger. Multiple installation options that maximize flexibility.



Order Code  
**63AK2674**

**AC/DC DIN RAIL POWER SUPPLY (PSU), 1 OUTPUT, 50.4 W, 12 VDC, 4.2 A**

The DRB-50-12-1 is a 12V/50.4W 1-output DIN-rail mount Power Supply features an ErP compliant design, compact size, high efficiency, low no load power draw, convection cooled and hiccup with auto recovery over-current protection. This power supply output is adjustable.



Order Code  
**18X3671**

**AC/DC OPEN FRAME POWER SUPPLY (PSU), ITE & MEDICAL, 1 OUTPUT, 40 W, 90V AC TO 264V AC**

The ECM range of single and multiple output AC-DC, 40-60 W power supplies from XP feature the world's smallest footprint for units of these ratings. Both are just 2" x 4" (50.8 mm x 101.6 mm) and 1.2" (30.48 mm) high.



Order Code  
**71J0110**

**RECHARGEABLE BATTERY, 3.6 V, NICKEL METAL HYDRIDE, 1.65 AH, AA, WIRE LEADS**

Battery Voltage:3.6V; Battery Technology:Nickel Metal Hydride; Battery Capacity:1.65Ah; Battery Size Code:Aa; Battery Terminals:Wire Leads; External Diameter:-; External Height:15.24Mm; External Width:43.18Mm; External Depth:53.34Mm Rohs Compliant: Na |Dantona Industries



Order Code  
**31AC8586**

**AC/DC PCB MOUNT POWER SUPPLY (PSU), FULL BRICK, ITE, 1 OUTPUT, 160 W, 24 V, 6.66 A**

ASB160PS24 is a 160W ASB160 series low profile, full brick, baseplate cooled AC to DC power supply which requires no external components.



Order Code  
**67AK7236**

**NON ISOLATED POL DC/DC CONVERTER, 300 W, 5 V, 28 V, 12.5 A, FIXED, ADJUSTABLE**

RGC series is a ruggedized non-isolated DC-DC buck-boost converter. The module has the industry standard 1/16th brick pin-out, are qualified to MIL-STD-810G (shock and vibration) and designed for fan-less, conduction cooled applications.



Order Code  
**69AK7665**

**EV PEDESTAL, DUAL PORT, WALL CHARGER**

Eaton Green Motion EV dual port pedestal charger enables faster and cost effective recharging of electric vehicles. Multiple installation options available like direct connect kit, direct connect kit + junction box, EV wall charger.



Order Code  
**63AK2673**

**AC/DC DIN RAIL POWER SUPPLY (PSU), ITE, HAZARDOUS LOCATIONS & LABORATORY, 1 OUTPUT, 480 W, 24 V**

The SolaHD SDN-D high performance DIN rail power supply boasts one of the highest efficiencies available in the market today. Higher efficiency means less heat is generated, potentially extending the life of all components in the enclosure.



Order Code  
**52AJ2407**

**AC/DC OPEN FRAME POWER SUPPLY (PSU), MEDICAL, 1 OUTPUT, 150W @ 200LFM, 100 W, 85V AC TO 264V AC**

The TLP150N-99S24J is a 1-output 150W open-frame AC/DC Power Supply with adjustable and fixed output voltage. It offers overvoltage, overcurrent and short-circuit safety protections. Because of its low profile, it fits 1U applications.



Order Code  
**77K8841**

**AC/DC POWER SUPPLY, DESKTOP, ITE, 1 OUTPUT, 160 W, 12 V, 12.5 A**

The AEJ160 series of ITE approved desktop adapter features active power factor correction and comply with the latest international efficiency requirements including Level VI and EU2019/1782.



Order Code  
**67AK7412**

**UNINTERRUPTIBLE POWER SUPPLY (UPS), 500VA / 300W, 120 V, 120 VAC, 4.2 MIN**

SDU AC - B series DIN rail uninterruptible power supply. It is suitable for use in programmable logic controllers, factory automation, robotics, conveying equipment and computer based control systems



Order Code  
**89AH0113**

**NON ISOLATED POL DC/DC CONVERTER, ITE, 750 W, 3.3 V, 18 V, 45 A, ADJUSTABLE**

The i7A series of up to 750W non-isolated DC-DC step-down converters are ideal for creating additional high current/high power 33A and 45A output voltage rails from a single output 24V, 36V or 48V AC-DC or DC-DC power supply.



Order Code  
**09AJ9510**

**RECHARGEABLE BATTERY, 3.6 V, NICKEL METAL HYDRIDE, 80 MAH, PCB PINS**

The COMP-16-2NMH is a 3.6V/80mAh Rechargeable Battery that features a nickel metal hydride technology and PCB pins terminals. This comp-series battery is ideal for computer (memory back-up).



Order Code  
**19C9477**

**UNINTERRUPTIBLE POWER SUPPLY (UPS), 8 OUTLETS, 2.2KVA / 1.92KW, 120 V, 120 V, 4.5 MIN**

Tripp Lite SM2200RML2UP line interactive 2U rack/tower UPS with 2200VA / 2.2kVA / 1920W capacity and extended runtime options. Line interactive UPS with Automatic Voltage Regulation (AVR) corrects brownouts and over voltages from 83 to 145V.



Order Code  
**67Y6215**



# Power supply choice made easy

XP Power are committed to helping customers find the right power solution for any application. Our diverse range of AC & DC products come with reliability designed-in and unrivalled service to match.

### Open-frame Power Supplies

- 5W to 450W
- World's smallest designs
- ITE & medical (BF) approvals



### Enclosed Power Supplies

- 10W to 5kW
- Full user configurability
- ITE & medical (BF) approvals



### External Power Supplies

- 5W to 300W
- Level VI & EU CoC Tier 2
- ITE & medical approvals



### DC-DC Converters

- 0.25W to 750W
- Through-hole & SMD
- ITE, medical and rail approvals



### High Voltage DC-DC

- Outputs up to 25kVDC
- Regulated & proportional
- Single & dual outputs



**XP** XP Power

POWERING THE WORLD'S CRITICAL SYSTEMS

## TRACO POWER

Reliable. Available. Now.

### Industrial Power Solutions

### DC/DC from 1–300 Watt

- Broad application range covering office, manufacturing, industrial, harsh and hazardous environments
- Industrial EMC immunity acc. to IEC 61000-6-2
- Various mounting types: PCB, Chassis-Mount and DIN-Rail
- Open-frame, encapsulated and encased package styles
- 3-years warranty

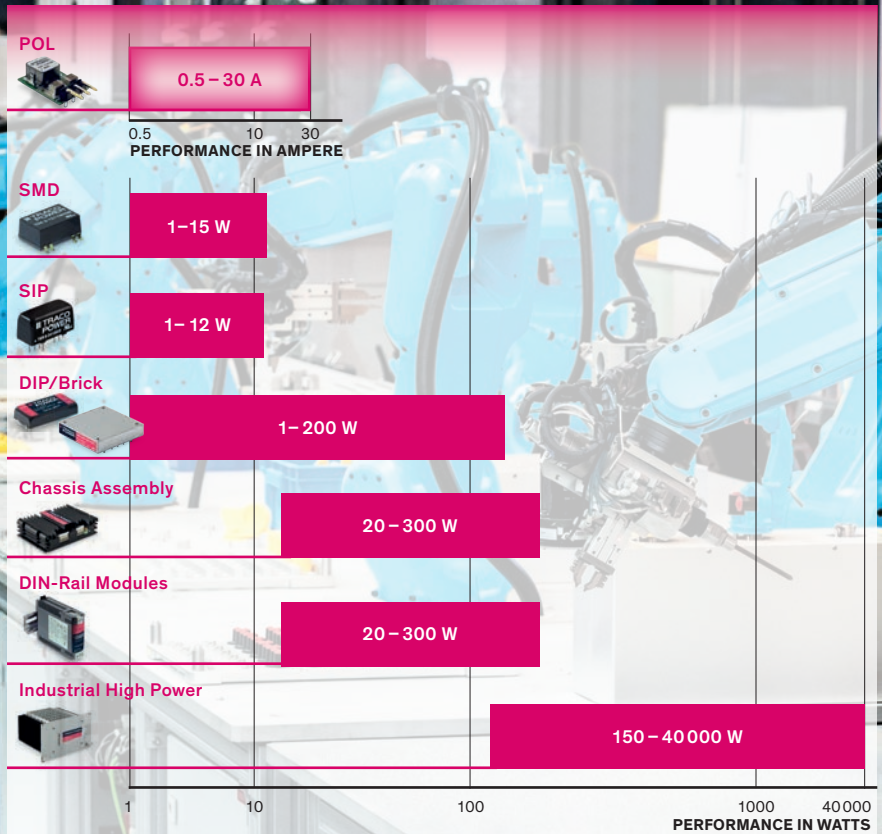

**ISOLATED THROUGH HOLE DC/DC CONVERTER, ITE, 1:1, 1W, 1 OUTPUT, 5 V, 200 MA**

The NME0505SC from Murata is an isolated, 1W, single output DC to DC converter in SIP package. It is particularly suited to isolate or convert DC power rails.



Order Code  
**61K3108**

**AC/DC ENCLOSED POWER SUPPLY (PSU), 1 OUTPUTS, 450 W, 24 V, 18.8 A**

24V 18.8A AC/DC Enclosed Switching Power Supply 450W power supply features active surge current limiting and AC range selection. Includes built-in fan for active cooling and LED status indicator.



Order Code  
**53Y1845**

**AC/DC OPEN FRAME POWER SUPPLY (PSU), ITE & MEDICAL, 1 OUTPUT, 100 W, 90V AC TO 264V AC, FIXED**

The MDS series of embedded power supply come with universal AC input at 90Vac to 264Vac. Other features include low touch current, risk management report available and the electric shock protection comply with 2 x MOPP



Order Code  
**52AH7281**

**DC/DC CONVERTER, ITE, 1 OUTPUT, 2.5 W, 5 V, 500 MA, AMSROL-78NZ SERIES**

Aimtec's AMSROL-78NZ series was developed to meet increasing market demand for compact sizes and higher efficiency. This 0.5A switching regulator hits the mark on these metrics with its 12.50 x 13.50 x 3.50mm open frame, ultra-low height design. It is also a viable replacement to the LM78 linear regulator.



Order Code  
**25AK2816**

**MULTICOMP PRO MPOF120-20B12 POWER SUPPLY, AC-DC, 12V, 9.5A ROHS COMPLIANT: YES**

This series is one of AC-DC miniaturize open frame power supply. It features universal AC input and at the same time accepts DC input voltage, cost-effective, high efficiency, high reliability and double or reinforced insulation.



Order Code  
**30AJ5447**

**DC/DC CONVERTER, ITE, 1 OUTPUT, 7.5 W, 5 V, 1.5 A, OKI SERIES**

The OKI-78SR series are non-isolated switching regulator (SR) DC/DC power converters for embedded applications. The fixed single output converters offer both tight regulation and high efficiency directly at the power usage site



Order Code  
**72R3616**

**ISOLATED DIN RAIL MOUNT DC/DC CONVERTER, RAILWAY, 4:1, 30 W, 1 OUTPUT, 24 V, 1.25 A**

DDR-30G-24 is a DDR-30 series 30W DIN rail type DC-DC converter with main features including easy installation, ultra slim width (35mm), 4:1 ultra wide input voltage, 4KVDC I/O isolation, adjustable output voltage ( $\pm 10\%$ ) and full protective functions.



Order Code  
**01AH7064**

**VARIABLE, MANUALLY OPERATED, OPEN, SINGLE PHASE, 50HZ / 60HZ, 240V, 280V**

The 236B is a POWERSTAT® Series 10A 240V single-phase Variable Transformer with knob rotation, motor drives and epoxy-coated POWERKOTE® coils for long life. This transformer provides continuously adjustable output voltage from utility line voltage.



Order Code  
**05F813**

**AC/DC OPEN FRAME POWER SUPPLY (PSU), ITE, 1 OUTPUT, 150W @ 10CFM, 120 W, 85V AC TO 264V AC, FIXED**

The AMEOF120-HAMJZ series is one of Aimtec's compact size 120W AC/DC converter with active PFC, which is also suitable for medical equipment.



Order Code  
**25AK2747**

**MULTICOMP PRO MPO02001 POWER SUPPLY, AC-DC, 24V, 6.5A ROHS COMPLIANT: YES**

The 150W enclosed power supply range has been specially designed to offer high efficiency, long life and high reliability for use in a variety of applications.



Order Code  
**51AH5982**

**RECHARGEABLE BATTERY, 12 V, LEAD ACID, 9 AH, QUICK CONNECT**

The HRL1234WF2FR is a Rechargeable Battery with F2 Faston tab 250 terminals. It is specially designed for high efficient discharge and long life application.



Order Code  
**27T6516**

**POWER SUPPLY, AC-DC, 24V, 2.5A ROHS COMPLIANT: YES**

The DRC-24V100W1A is part of the Chrome DIN Rail Power Supply series, which is designed for use in compact cabinets for home automations and the food and beverage industry. Delta's Chrome DIN Rail Power Supply series offers double isolated input.



Order Code  
**25AJ0757**

**VARIABLE, PLUG IN, MANUALLY OPERATED, 50HZ / 60HZ, 120V, 140V**

The 3PN1010B is a Variable Transformer featured with a ventilated steel case, input line cord and plug, fused NEMA rated output receptacle and an illuminated on/off switch.



Order Code  
**83F2006**

**DC-DC LED DRIVER, 36V, 0.7A, ANALOGUE ROHS COMPLIANT: YES**

High Power LED Driver, Constant Current Output mode, Ultra Wide Input Voltage Range, High Efficiency (Up to 96%), Remote ON/OFF Function, PWM & Analogue Dimming Function, SMD Package, Operating Temperature range  $-40^{\circ}\text{C}$  -  $+85^{\circ}\text{C}$



Order Code  
**57AK2637**

**MULTICOMP PRO MP-K7805MT-500R4DC-DC CONVERTER, 5V, 0.5A ROHS COMPLIANT: YES**

The MP-K78\_MT-500R4 series are high efficiency switching regulators. The converters feature high efficiency, low loss and short-circuit protection in a compact DFN package. These products are widely used in applications such as industrial control, instrumentation and electric power.



Order Code  
**92AH5612**

# Unlocking the Secrets of Reliable Relays: OMRON's Unique Production Know-How

Creating the perfect relays may seem like a straightforward task, but it's a complex process that requires the most advanced manufacturing processes. This ensures that every component inside our relays are precisely assembled and protected from any outside contaminants. Ignoring this crucial step could jeopardize the reliability of the relays and compromise their switching activity.

**At times, machines can experience unplanned downtime**, with the causes remaining elusive, in many cases restarting the machine or replacing the relays resolves the issue.

**OMRON determined that such incidents are primarily caused by inadequate contact conduction, which frequently results from dust caught between the contacts during manufacturing.**

This dust is generated from various sources such as:

- Resin scrap from relay parts
- Textile fibres from operator clothing

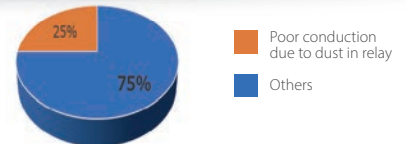

OMRON research has revealed that poor conduction of the contacts is the primary cause of relay faults, accounting for approximately 75% of cases.

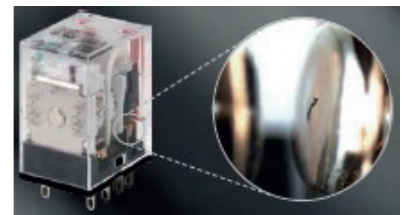

## OMRON'S SOLUTION TO PREVENT POOR CONDUCTION IN RELAYS

**To improve the reliability of our relay production, OMRON has made three key commitments:**

- Provide standardised product design to avoid the generation of dust.
- Produce products in clean rooms with strict entry exit controls to prevent the introduction of dust.
- Utilize OMRON's unique dust removal technology to avoid leaving dust behind during the production process.

With these commitments, OMRON can ensure the highest quality and reliability for your industrial needs.

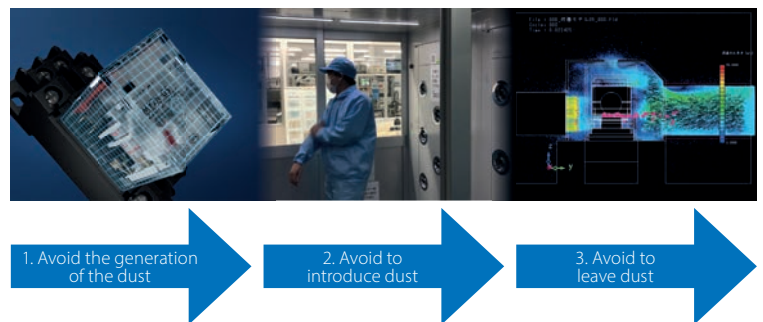

## OMRON relays offer supreme quality

For more than half a century, OMRON has dedicated itself to the design and production of relays and has now become the largest manufacturer of single-brand relays worldwide. Among our most significant electromechanical relay families are the G2RS, MY, G2RV, and LY families. Now in 2023, OMRON has revamped their relay product line, unveiling the slim G2RV-ST relay and promoting the MY-GS-R as the flagship model for the MY family.



### G2RV-ST:

The relay itself is a well-known standard 6mm relay with industrial pins, but the socket has been redesigned with enhanced features, such as:

- Security lever to avoid accidental relays fall.
- Super bright Brilliant LED.
- Up to 2.5mm<sup>2</sup> cable wiring dimensions.
- Captive screw and push-in plus wiring technology available.



### MY-GS-R:

The MY-GS-R is the newest member of the MY family, distinguished by its exceptional features, making it the flagship model.

These features include:

- Supreme reliability due to fully automated production.
- No polarity required for DC coil specification models with LED, available in both 2-pole and 4-pole types, simplifying wiring and maintenance activities.
- Convenient identification of AC and DC types: red test button + red LED for AC coil, blue test button + green LED for DC coil.
- 2.6mm wide pins for enhanced conductivity in MY plug-in terminals.



**POWER RELAY, DPDT, 24 VDC, 5 A, G2RS SERIES, SOCKET, NON LATCHING**



The Omron G2RS series are industrial plug-in relays. These electromechanical power relays are slimline, space saving relays with enhanced features mainly used for general purpose applications.



Order Code  
**14J0623**

**POWER RELAY, 4PDT, 24 VDC, 5 A, MY SERIES, SOCKET, NON LATCHING**



MY(S) series miniature power relay with 4PDT contact form and DC coil. It is a versatile plug-in relay without LED indicator and it reduces wiring work by 60% when combined with PYF-PU push-in plus socket.



Order Code  
**18J7481**

**POWER RELAY, SPDT, 24 VDC, 6 A, G2RV SERIES, DIN RAIL, NON LATCHING**



The Slim I/O Relay G2RV-SR/ G3RV-SR is a low profile slim I/O relay with width 6.2 mm. Realized about 25% lower profile than conventional products, contributing to further miniaturization of the control panel.



Order Code  
**90Y9347**

**SOLID STATE RELAYS**



Single phase SSRs with TRIAC or SCR output. Control voltage 4-32VDC or 90-280VAC. Load voltage 240VAC, 480VAC or 600VAC. Wide load current range from 10-125A.



Order Code  
**24AC9515**

**SIGNAL RELAY, 5 VDC, DPDT, 1A, TQ SERIES, THROUGH HOLE, NON LATCHING**



The TQ series from Panasonic are through hole signal relays. These mechanical relays are mainly used in signal control applications such as communications, measurement equipment, OA equipment and industrial machines.



Order Code  
**04M7538**

**SOCKET, DIN, 5MM PITCH, SCREW TERM**



For Industrial Power Relay RT pinnings 3.5 mm / 5 mm; relay height 15.7 mm. Features include, new retainer clip with ejection function, easy replacement of relays on a densely packed DIN rail and no reduction of protection class or creepage/clearance with plastic retainer.



Order Code  
**50M4792**

**RELAY, 3PST-NO, 250VAC, 16A**



the features include printed circuit mount 16 A Power relay, 2 & 3 Pole changeover contacts or NO ( $\geq 3$  mm contact gap), AC coils & DC coils, reinforced insulation between coil and contacts according to EN 60335-1, with 6 mm clearance & 8 mm creepage distance.



Order Code  
**35M2006**

**TESYS DECA CONTACTOR**



The LC1D25BD is a TeSys D 3-pole Contactor with 3NO power pole and 1NO-1NC auxiliary contacts. TeSys D contactor is designed for perfect integration in control systems. It can be used to create motor starters for any type of application.



Order Code  
**53M4989**

**POWER RELAY, 4PDT, 24 VDC, 7 A, 58 SERIES, DIN RAIL, DC**



The 58.34.9.024.0050SMA is a 4-pole Relay Interface Module with DC coil, 58.34 series. 4CO (4PDT) contact configuration, AgNi, cadmium-free contact. Ideal interface for PLC and electronic systems. Standard for DC green LED + diode (polarity +A1).



Order Code  
**31M0823**

**RELAY, SPDT, 250VAC, 6A**



The common features of the 39 SERIES MasterINTERFACE - Relay interface modules include, space saving 6.2 mm wide, connections for 16-way jumper link, integral coil indication and protection circuit and secure retention and easy ejection by plastic clip.



Order Code  
**48W3828**

**RELAY, DPDT, 240VAC, 12A**



The relay package consisting of PT relay, DIN-rail socket, plastic retaining clip, module and marking tag. It also consists of 2 pole 12 A, 3 pole 10 A or 4 pole 6 A, DC- or AC coil, mechanical and electrical indicator and manual test tab, optionally lockable.



Order Code  
**97K7886**

**TESYS DECA CONTACTOR**



The LC1D32F7 is a TeSys D 3-pole Contactor with 3NO power pole and 1NO-1NC auxiliary contacts. TeSys D contactor is designed for perfect integration in control systems. It can be used to create motor starters for any type of application.



Order Code  
**79C9633**

**AUTOMOTIVE FUSE, FORK LIFT TRUCK, 48 V, 100 A, FAST ACTING, 157.5700 SERIES ROHS COMPLIANT: YES**



Fuse Strips Rated 48V - Special Purpose Fuses (not intended for automotive or truck applications). Non-housed fuse strips for battery powered fuses rated at 48VDC. 90° and straight fork type lugs.



Order Code  
**50M6238**

**AUTOMOTIVE FUSE, FORK LIFT TRUCK, 48 V, 250 A, FAST ACTING, 20MM X 82MM X 10.5MM ROHS COMPLIANT: YES**



Fuse Strips with Housing Rated 48V - Special Purpose Fuses (not intended for automotive or truck applications). Housed fuse strips for battery-powered vehicles. Current rating 35A - 500A, 48 VDC. 90° and straight fork type lugs.



Order Code  
**35M0314**

**CC-TRON SERIES**



Fuse, Industrial / Power, CC-TRON Series, 15 A, 600 VAC, 10.3mm x 38.1mm, 13/32" x 1-1/2"



Order Code  
**91F6000**



**Technical experts** providing convenient, tailored and **innovative industrial sensing and connectivity solutions.**



## Our Products



Temperature



Pressure



Flow



Force & Strain



Level



Data Acquisition



Test & Inspection



Control & Monitoring



Calibration Systems



Industrial Heaters



IIoT & Wireless



Custom & Configured



**THERMOMETRICS INLINE FLOW-THROUGH FLUID TEMPERATURE SENSOR**

**Amphenol**  
Advanced Sensors

Monitors the temperature of liquid that passes through it, system control module receives this temperature reading and uses it to control the overall system temperature.



Order Code  
**24AC6270**

**K50R RADAR SENSOR : SHORT-RANGE SENSOR FOR ROBUST OBJECT DETECTION**



Radar-Based Sensors for detection and measurement of moving and stationary targets.



Order Code  
**33AK7711**

**FULL METAL INDUCTIVE PROXIMITY SENSORS WITH IO-LINK COMMUNICATION**



On-board IO-Link communication opens up many possibilities, such as easy configuration and setup of the devices and advanced parameter setting.



Order Code  
**65AK6225**

**BAS BATTERY AEROSOL SENSOR**

**Honeywell**

The BAS Series Sensors are built to detect the presence and concentration of aerosols such as smoke, liquid and debris in lithium-ion battery packs.



Order Code  
**65AK6199**

**CO2 SENSOR MODULE FOR HARSH ENVIRONMENTS**

**Amphenol**  
Advanced Sensors

A range of carbon dioxide sensors designed measure CO2 in harsh or difficult environments. Applications include medical, food, transport and agricultural applications including glass houses mushroom sheds and chicken sheds.



Order Code  
**01AC3557**

**Q4X RUGGED LASER DISTANCE SENSOR : THE ULTIMATE PROBLEM SOLVER**



Durable and robust construction resists mechanical impact, over tightening and extreme vibration.



Order Code  
**43AJ7032**

**MC36C COMPACT SAFETY MAGNETIC SENSORS**



The MC36C series are encoded safety magnetic sensors with compact housing used to monitor the position of hinged, sliding or removable guards of industrial applications.



Order Code  
**08AJ1649**

**5000 SERIES INDUSTRIAL PRESSURE SWITCH WITH SCREW ELECTRICAL CONNECTION**

**Honeywell**

78303-B00000400-14 is a 5000 series pressure switch with screw electrical connection. 5000 Series pressure switch is specifically designed to stand up to extended duty applications.



Order Code  
**40T3501**

**BATTERY LEAKAGE DETECTION SENSOR**



SGX-BLD2 is a Hydrogen and Battery Leakage Detection sensor that measures H2 concentration when different battery leakage occur through CAN communication.



Order Code  
**33AK4000**

**HIGH SPEED OPTICAL LABEL SENSOR**



Sensor can be configured to detect the label or the backing paper.



**52AH6847**

**THERMAL REED SENSORS, SCREW TYPE**



TRS series screw type thermal reed switch is a highly reliable, precise temperature-sensitive switch ideal for energy conservation.



Order Code  
**21AJ9315**

**500A OPEN LOOP CURRENT SENSORS**

**Honeywell**

The CSHV Series are open loop current sensors that use Hall-effect sensing and patented Honeywell technology to bring the best combination of performance and reliability for current sensing applications.



Order Code  
**65AK6211**

Take complete control of your machine.

Material detection regardless of light, shape, color, dust, or density.

Electromechanical pressure switch

**9013FHG44J59M1X**



Ultrasonic Sensors  
Wide Beam

**XXW54P3HPL01DM6**

Simply easy!  
tesensors.com

**Telemecanique**  
Sensors



**MINIATURE THERMOCOUPLE CONNECTOR, PLUG, IM-K-M, TYPE K, IEC**

The IM-K-M (IEC) from Labfacility is a miniature thermocouple connector with flat pins to suit thermocouple type. Ideal for general purpose use.



Order Code  
**67C1559**

**3KG PULL MAGNET THERMOCOUPLE, TYPE K, IEC**

Magnet Thermocouple with 2m stainless steel over-braided PFA-PTFE cable fitted with miniature plug.



Order Code  
**88T2877**

**PANEL MOUNTABLE CURRENT TRANSDUCER**

Bipolar and insulated measurement up to 1500V.



Order Code  
**99Y8151**

**HANI CLAMP MOUNT INDUSTRIAL TEMPERATURE SENSOR FOR USE ON PLASTIC PIPES**

Monitor the temperature of in-pipe fluid media in your plastic piping system with HANI clamp sensor for plastic pipes. Easy-to-install with zero downtime, this sensor will be a game changer for temperature measurement and control in the most challenging applications.



Order Code  
**65AK5622**

**PRESSURE SENSOR, 300 PSI, ANALOGUE, GAUGE, 30 VDC, 1/4" - 18 NPT**

PX319 series high performance general purpose pressure transducer uses two state-of-the-art silicon technologies. It has an accuracy of  $\pm 0.25\%$  FS BSL (Combined Linearity, Hysteresis and Repeatability).



Order Code  
**30AC8212**

**BARREL-STYLE INDUCTIVE PROXIMITY SENSOR**

Pepperl+Fuchs offers innovative, high quality inductive sensors to meet the needs of the worldwide automation and process control markets. This product offers accurate, non-contact detection of metallic objects in machinery or automation equipment.



Order Code  
**22C9477**

**B5WC BUILT-IN COLOR SENSOR FOR RELIABLE DETECTION OF CHANGES AND DIFFERENCES IN COLOR**

B5WC Built-in color sensors from Omron improve equipment maintenance efficiency by monitoring the change in liquid color.



Order Code  
**61AK0053**

**FLAT CAPACITIVE PROXIMITY SENSOR**

Flat Capacitive Sensor with excellent space efficiency, used for detecting ferrous metal.



Order Code  
**27M2369**

**RECTANGULAR STANDARD PROXIMITY SENSOR**

TL-Q5MC1 is a rectangular standard inductive Proximity Sensor with heat-resistant ABS resin case and sensing surface.



Order Code  
**27M2896**

**INTELLIGENT PARTICLE SENSOR FOR ACCURATE AIR QUALITY MONITORING**

IPS-7100-1 is a photon counting readout based, highly sensitive optoelectronic particulate sensor. It is capable of fast data acquisition and readout as well as categorizing particulates based on the size. Adjustable sensitivity controls provide superior accuracy and versatility.



Order Code  
**45AK2308**

**SFC6000D MASS FLOW CONTROLLER WITH MULTI-GAS CALIBRATION**

20 - 0.04slm flow range Disruptive concept combining plastic body and highly integrated electronics. Small form factor and low weight. High accuracy/repeatability (2% / 0.2% of set point).



Order Code  
**67AK1903**

**CO2, HUMIDITY AND TEMPERATURE SENSOR MODULE**

Ambient humidity and temperature can be measured by Sensirion's algorithm expertise through modelling and compensating of external heat sources without the need of any additional components.



Order Code  
**56AC2776**

**MINIATURE THROUGH BEAM PHOTOELECTRIC SENSOR, W4F SERIES**

The Smart Sensors in the W4F product family, which are powered by IO-Link, are ready for the most demanding Industry 4.0 applications. Practical features for intelligent monitoring and predictive maintenance ensure a very high reliability in operation.



Order Code  
**60AK9208**

**100LB COMPACT COMPRESSION LOAD CELL**

TE Connectivity's (TE) FX29 is a compact compression load cell that offers exceptional price-to-performance in a robust sensor package.



Order Code  
**40AH0491**

**Ø54 WIDE BEAM ULTRASONIC SENSOR, OBSTACLE DETECTION SYSTEM, CONFIGURABLE BY SOFTWARE**

Ultrasonic Wide Beam Sensor, XX Series



Order Code  
**68AK0791**

**SERIES MPIO02 VANDAL RESISTANT SWITCH**

Manufactured from Stainless Steel, Bulgin's extensive range of vandal resistant security switches are designed with a high resistance to wear and tear, corrosion and harsh use in potentially hostile environments such as access control applications.



Order Code  
**75M3520**

**MRSS SERIES MINIATURE ROTARY SWITCH**

The MRSS addresses manual programming applications. These high-quality rotary DIP switches are available in size 7.7mm square (horizontal) and 7.2mm square (vertical) for a wide range of possible applications like elevator and security system.



Order Code  
**60AK9626**

**SERIES 45 EMERGENCY STOP SWITCHES**

Series 45 emergency stop switches offer reliable protection for both man and machine in the event of application malfunctions – on a factory conveyor belt, for instance. Thanks to intuitive operation and IP69K rated features, these switches perform safely and securely as often required in harsh, industrial environments.



Order Code  
**05AC2265**

**PV2 SERIES VANDAL RESISTANT SWITCH**

The PV2F640SS is an Anti-vandal Switch offers long life expectancy. It features screw terminals, single pole off-(on) function, polished stainless steel body and flat actuator. These can be found on kiosk and public ticket dispenser applications, along with other industrial type applications.



Order Code  
**24R3494**

**PTS645 SERIES 6 MM TACT SWITCHES**

Designers for power tooling, set top and access boxes, instrumentation and general consumer products turn to C&K's PTS645V series of 6mm SMT side actuated tact switches to give their products the reliability and long life demanded by regular use.



Order Code  
**59AK7062**

**SERIES MP0037 VANDAL RESISTANT SWITCH**

Manufactured from Stainless Steel, Bulgin's extensive range of vandal resistant security switches are designed with a high resistance to wear and tear, corrosion and harsh use in potentially hostile environments such as access control applications.



Order Code  
**48F2532**

**PBES16L SERIES EMERGENCY STOP SWITCH**

The PBES16 Series has a 20N actuation force for ruggedized applications to avoid accidental actuations and is also IP65 rated to withstand harsh environments. This series has multiple lighting options, agency approvals, and meets IEC 60947-5-1 & IEC 60947-5-5 standards.



Order Code  
**50AJ0274**

**ST4 SERIES SEALED TOGGLE SWITCH**

The ST4 Series sealed toggle switches are rated IP68 for dust and moisture protection and offer single pole or double pole circuit functions with 2 or 3 actuator positions. Select from 10 different function options, three electrical rating options, and 17mm metal or 22mm plastic bat actuator.



Order Code  
**57AJ6016**

**57 SERIES MINIATURE VANDAL RESISTANT PUSHBUTTON SWITCHES**

The Series 57 is a range of miniature, momentary action, rugged panel sealed push-button switches with a round button and bezel. The Series is available with or without LED status illumination. The body and button are manufactured from anon-spark zinc alloy and are velour chrome plated.



Order Code  
**31C7633**

**V19 SERIES BASIC SWITCH**

Honeywell Sensing and Internet of Things announced a new addition to their MicroSwitch products, the V19 basic switch for appliance customers. The V19 is focused on empowering White Goods designs with a balance between configurability and cost.



Order Code  
**75AH8766**

**MP0042/3 VANDAL RESISTANT SWITCH**

The MP0042/3 is a momentary Vandal Resistant Switch with screw termination, SS push to make switching, nylon moulding, silver-plated brass tags, polished stainless steel body and button, silver contacts.



Order Code  
**95M9941**

**PBES16N SERIES EMERGENCY STOP SWITCH**

PBES16 series pushbutton emergency stop switch is a non-illuminated switch. It has a 20N actuation force for ruggedized applications and to avoid accidental actuations and is IP65 rated to withstand harsh environment. Features include, 16mm mounting hole, high actuation force UL and TV agency approved and more.



Order Code  
**50AJ0283**

**ST5 SERIES HIGH TEMPERATURE TOGGLE SWITCH**

The ST5 series toggle switch series can handle temperatures ranging from -10°C to 125°C. The ST5 offers a single pole or double pole circuit function with two or three positions and offers three electrical rating options.



Order Code  
**62AJ3543**

**KSC4 TE SERIES TIRELESS ENDURANCE TACT SWITCH**

KSC4 TE tireless endurance tactile switch is a new KSC4 configuration with J leads, a soft actuator and a renewed combination of dome and support, upgrading the lifetime up to 10 million cycles. Its size makes it perfect for demanding applications such as applications in the industrial segment.



Order Code  
**31AJ3572**

**YW SERIES CONTROL UNITS**

Ensure safety and save wiring time with YW Series Control Units. Main features include Safety Lock Mechanism, Direct Opening Action, Safe Pushbutton Design and more.



Order Code  
**28X7160**

**XB4BD21**



The XB4BD21 is a 2-position black Voltage Selector Switch with screw clamp terminals. It features 1NO contact configuration and slow-break contact operation function. The switch is made of chromium plated metal bezel with silver alloy contacts.



Order Code  
**39C6738**

**CP1 SERIES**



Pushbutton Switch, SPST-NO, 1.5A, SCREW; Product Range: CP1 Series; Panel Cutout Diameter: 22.3mm; Contact Configuration: SPST-NO; Switch Operation: Momentary; Pushbutton Actuator Style: Round Flush; Actuator / Cap Colour: Green



Order Code  
**14AC1021**

**SERIES 59**



The Series 59 is a range of miniature, momentary action, rugged panel sealed pushbutton switches. The Series is available with square or round bezel versions, with or without LED status illumination and in a variety of button types.



Order Code  
**06WX7470**

**PVK4 ANTI-VANDAL SELECTOR SWITCH**



Selector Switch Anti-vandal DPDT On-On 2A 24VDC, 2 Position return On-(On), Red Led illumination, Base voltage Keylock Switch DPDT On-On-On 2A 24VDC, 3 Position maintain On-On-On.



Order Code  
**57AK6054**

**IP68 POWER-SEALED TOGGLE SWITCHES**



IP68 Rated copper alloy, silver plated power-sealed toggle switches. Search for skus 69AK7836 to 69AK7837.



Order Code  
**69AK7836**

**D2D SERIES**



D2D-1000 Safety Interlock Switch, D2D Series offer offers the minimum contact gap of 3 mm required for power switches as standard equipment. Safety considerations include a double return spring and direct drive positive contact opening feature.



Order Code  
**93B9088**

**AV SERIES**



PB SWITCH, SPST-NC/NO, 1A, 30VDC, PANEL; Product Range: AV Series; Panel Cutout Diameter: 19mm; Contact Configuration: SPST-NO, SPST-NC; Switch Operation: Momentary; Pushbutton Actuator Style: Round; Actuator / Cap Colour:Natural



Order Code  
**32AH7975**

**SL SERIES**



PN SL0001-1 C&K's SL series IP67 sealed door interlock switch features push (momentary)/ pull (maintained) motion as well as SPDT and DPDT in 3 different bracket sizes (small, large and extended), multiple mounting configurations.



Order Code  
**24AK8245**

**ANTI VANDAL PUSH BUTTON SWITCHES**



IP67 rated illuminated stainless steel Anti Vandal Push Button Switches. Search for skus 69AK7740 to 69AK7743.



Order Code  
**69AK7741**

**IP65 RATED ROCKER SWITCHES**



IP65 Rated DPST, On-Off Rocker Switches. Search for Skus 68AK5720 to 68AK5722.



Order Code  
**68AK5720**

**SERIES B3F**



The Omron B3F series are tactile switches. These switches are available in 6mm x 6mm, 12mm x 12mm sizes with different models such as standard, side operated, long durability, high force and high reliability gold plated etc.



Order Code  
**36K7138**

**PB SERIES**



The 1PB5 is a single-pole double-throw (SPDT) miniature Pushbutton Switch with a natural round actuator, ON-(ON) function and solder terminals. It is equipped with HM hermetically sealed switch unit, which has metal-to-metal fusion around the cover, actuator base and mounting holes.



Order Code  
**23F1867**

**SERIES 82 IP67 ON/OFF SWITCHES**



EAO's Series 82 anti-vandal stainless steel On/Off and Standby switches are suitable for 16, 19 or 22 mm mounting and have built-in resistors for easy direct connection to a 12V or 24V supply.



Order Code  
**33AC4209**

**INDUSTRIAL PUSH BUTTON SWITCHES**



SPDT, Momentary, Round Flat, Industrial Pushbutton Switches. Search for skus 69AK7732 to 69AK7737.



Order Code  
**69AK7732**

**HIGH CURRENT ANTI VANDAL PUSH BUTTON SWITCHES**



IP65 rated high current stainless Steel anti vandal push button switches. Search for skus 69AK7836 to 69AK7837.



Order Code  
**69AK7765**



**1GHZ EIGHT CHANNEL MIXED SIGNAL OSCILLOSCOPE**



5 Series Mixed Signal Oscilloscope offers better visibility into complex systems with eight FlexChannel inputs and 15.6" high-definition touchscreen display.



Order Code  
**83AJ0736**

**1GHZ SIX CHANNEL MIXED SIGNAL OSCILLOSCOPE**



4 Series Mixed Signal Oscilloscope features a highly intuitive user interface, six FlexChannel inputs and 13.3" high-definition touchscreen display



Order Code  
**02AH4138**

**1.5MHZ FOUR CHANNEL MIXED SIGNAL OSCILLOSCOPE SOFTWARE BUNDLE**



1.5GHz Mixed Signal Oscilloscope bundle features multiple options; ARB generator, low speed serial buses, automotive protocols and Bode plot analysis all included.



Order Code  
**70AK5603**

**FOUR CHANNEL 640W PROGRAMMABLE POWER SUPPLY**



Bench or rack programmable power supply features four galvanically isolated floating channels, each able to deliver up to 32VDC at 20A, with total output of 384 Watts



Order Code  
**50AC9964**

**800W AUTORANGING PROGRAMMABLE POWER SUPPLY**



The E36154A is an 800W, 30V, 80A autoranging benchtop single power output DC power supply. It includes advanced characterization tools such as data logging, an optional scope view and arbitrary waveform generation.



Order Code  
**53AK8194**

**800W AUTORANGING PROGRAMMABLE POWER SUPPLY**



Single output autoranging programmable power supply boasts 4.3" touchscreen display, remote sensing and up to 800W output.



Order Code  
**53AK1166**

**120 CHANNEL DATA ACQUISITION UNIT**



Combined with a variety of input modules, this DAQ provides measurement and data collection from up to 120 channels.



Order Code  
**72AC4094**

**80 CHANNEL DATA ACQUISITION UNIT**



DAQ provides measurement and data collection from up to 80 input channels and control of up to 12 output channels.



Order Code  
**51AC7225**

**80 CHANNEL DATA ACQUISITION UNIT**



High speed DAQ mainframe features eight slots which accept 21 available modules, with scan rate of up to 1,000 channels per second.



Order Code  
**56J9919**

**SINGLE CHANNEL FOUR QUADRANT SOURCE METER®**



Source measurement meter features a 5" touchscreen which facilitates ease of use while optimizing speed and productivity. Four quadrant operation provides the capabilities of analyzers, curve tracers, and I-V systems at a fraction of their cost.



Order Code  
**88W3815**

**SINGLE CHANNEL FOUR QUADRANT SOURCE METER®**



Source measurement meter features 100V/10A high current output for higher capacity applications. Four quadrant operation provides the capabilities of analyzers, curve tracers, and I-V systems at a fraction of their cost.



Order Code  
**77Y6596**

**SINGLE CHANNEL FOUR QUADRANT SOURCE METER®**



Source measurement meter features 200V/10A high current output for higher capacity applications. Four quadrant operation provides the capabilities of analyzers, curve tracers, and I-V systems at a fraction of their cost.



Order Code  
**44W8036**

**5MHZ FUNCTION GENERATOR**



5MHz single channel function generator provides a standard waveform output and is ideal for EDU environments.



Order Code  
**22C6860**

**20MHZ ARB FUNCTION GENERATOR**



20MHz ARB Function generator features modulation, sweep, and burst signals, plus LAN and GPIB interfaces that simplify instrument control and transfer of waveforms to the instrument.



Order Code  
**94T6987**

**DUAL CHANNEL 20MHZ ARB FUNCTION GENERATOR**



20MHz dual channel ARB Function generator features modulation, sweep, and burst signals, plus LAN and GPIB interfaces that simplify instrument control and transfer of waveforms to the instrument.



Order Code  
**94T6990**

**ii910 SONIC IMAGER**



The ii910 is the all-in-one tool you have been looking for when it comes to all of your leak and Partial Discharge issues.



Order Code  
**92AH2695**

**TECHNICIANS DIGITAL MULTIMETER, 110 SERIES, 6000 COUNT, TRUE RMS, AUTO, MANUAL RANGE, 3.5 DIGIT**



For general purpose electrical and electronic test requirements, the Fluke 115 true-rms digital multimeter provides the perfect answer. Its simple operation, compact design and ease of use makes it perfect for quick verifications and field service use.



Order Code  
**83K1718**

**HANDHELD DIGITAL MULTIMETER, 6000 COUNT, TRUE RMS, AUTO, MANUAL RANGE, 3.75 DIGITS**



IP54 rated true RMS digital multimeter with type K temperature function an ideal tool for electricians, service technicians and HVAC professionals.



Order Code  
**34AC9586**

**TI-480 PRO THERMAL IMAGER**



Fluke Ti480 PRO 60Hz infrared camera capture accurate measurements with this infrared camera making it ideal for working in tough industries. The rugged pistol-grip design enables thermographer to focus on their surroundings. Additionally, the SuperResolution mode feature provides 4x the standard resolution.



Order Code  
**47AC8649**

**OSCILLOSCOPE PROBE, HIGH-VOLTAGE DIFFERENTIAL PROBE, 30 MHZ, 240 VAC, 10:1, 100:1, OSCILLOSCOPES**



The CT4447 series probe convert these floating signals to low-voltage ground referenced signals that can be displayed safely on any ground-referenced oscilloscope. Compatible with oscilloscopes (with 1Mohm input) from all major manufacturers.



Order Code  
**32AK6178**

**POWERPAD IV**



The PowerPad® model 8345 is a portable three-phase, Class A Power Quality Analyzer that enables technicians and engineers to measure and perform diagnostics and power quality work on one, two or three phase networks.



Order Code  
**50AK8502**

**HANDHELD DIGITAL MULTIMETER, 170 SERIES, 6000 COUNT, TRUE RMS, AUTO, MANUAL RANGE, 3.75 DIGIT**



With its precision, reliability, and ease of use, the Fluke 179 True RMS Digital Multimeter is the preferred solution for professional technicians around the world.



Order Code  
**25C4804**

**TELEDYNE FLIR ONE EDGE PRO**



FLIR ONE Edge Pro is an innovative, rugged thermal imager that wirelessly connects to your smart device so you can remotely inspect out-of-reach targets – or clip it onto your phone or tablet for one-handed operation



Order Code  
**60AK4377**

**TEST LEAD SET, ALLIGATOR CLIP TO ALLIGATOR CLIP, 70 V, 5 A, 609.6 MM, 10 LEADS**



The 6356-24 is a Test Lead Set with alligator clip at both ends. This patch cord is ideal for use as a temporary jumper wire.



Order Code  
**94B5529**

**MODULAR POWER SUPPLY, 1 OUTPUTS, 5 KW, PROGRAMMABLE, 0 V, 200 V, 70 A**



EA-PS 10200-70 3U is a PS 10000 series DC laboratory power supply convert the energy from the grid into a regulated DC voltage with a high efficiency. The DC supply operates as a flexible output stage with a constant power characteristic (autoranging), and a wide voltage, current and power range



Order Code  
**58AK8644**

**FLUKE SMFT-1000/PRO KIT**



Designed for PV professionals that provide installation, commissioning and maintenance services to systems that operate at 1000V DC or under, the SMFT-1000 provides a complete PV testing solution that conforms to IEC 62446-1 standards.



Order Code  
**57AK7519**

**HANDHELD DIGITAL MULTIMETER, AC CURRENT, AC/DC VOLTAGE, CONTINUITY, FREQUENCY, RESISTANCE, 4**



The Megger MET1000 is a multifunctional voltage and current tester providing electricians and electrical engineers a versatile and robust hand-held all-in-one meter, with detachable test leads.



Order Code  
**27AJ4148**

**TELEDYNE FLIR T540-24**



The FLIR T540-24 is a FLIR T500 series professional thermal imaging camera with 24° lens. The portable, ergonomic thermal camera offer advanced features like 1-touch level/span and continuous laser assisted autofocus.



Order Code  
**34AC9593**

**TEST LEAD SET, INSULATED MINI, ALLIGATOR CLIP TO ALLIGATOR CLIP, 300 V, 7 A, 304.8 MM, 10 LEADS**



The BU-00287 is a 12-inch 300V Insulated Mini-Alligator Lead Set. Clip nickel-plated steel with PVC insulator. 22AWG (19/34) copper hook-up wire with 105°C PVC insulation.



Order Code  
**83F8070**

**FLUKE SMFT-1000/PRO KIT**



Designed for PV professionals that provide installation, commissioning and maintenance services to systems that operate at 1000V DC or under, the SMFT-1000 provides a complete PV testing solution that conforms to IEC 62446-1 standards.



Order Code  
**57AK7519**

## LOOP CALIBRATOR



Hand-held loop calibrator with stable performance and up to 0.02% high accuracy. Measures DC voltage/current and loop current, source/simulate DC current. Designed with auto stepping and ramping, the 25% stepping function can be used for fast linearity detection.

Order Code  
**07AH2541**



## MP760607 CLAMP METER



The MP760607 is a portable true RMS AC/DC clamp meter with automatic range, designed according to EN61010-1 CAT II 600V / CAT III 300V safety standards, and comes with full-function protection which ensures users a safe and reliable measurement experience.

Order Code  
**13AJ0605**



## HUMIDITY METER



The MP780117 from Multicomp Pro is a handheld temperature humidity meter, featuring split-type probe and probe holder.

Order Code  
**42AH0487**



## HANDHELD DIGITAL MULTIMETER



The MP730651 is a 1000V true RMS digital multimeter which offers high levels of reliability and security, with a 6000 count display. With a large screen, high resolution analogue pointer display, full scale overload protection and unique appearance design, the device is an extremely practical electrical measuring meter.

Order Code  
**90AH9782**



## MINI AC LEAKAGE CURRENT TESTER, 200A



Miniature AC leakage current test meter with LCD display, 30mm shielded transformer jaw and a data hold function that allows for easy reading in dimly lit locations.

Order Code  
**07AH4392**



## FIBRE OPTIC TESTER, -50DBM-26DBM



The MP700122 from Multicomp Pro is a handheld optical power meter, used to measure absolute optical power or relative loss of optical power through length of fiber optic wires. This product is designed to be durable, the meter can withstand a 2m drop and has a dust/water resistance rating of IP65.

Order Code  
**42AH0475**



## SMART DIGITAL MULTIMETER



MP730835 is a smart digital multimeter, which automatically identifies both the required function and range which leads to improved operation and efficiency.

Order Code  
**29AK2508**



## ARBITRARY WAVEFORM GENERATORS, 2 CHANNEL WITH TFT LCD SCREEN



Two new AWGs from Multicomp Pro

Order Code  
**53AJ6162**



## TABLET OSCILLOSCOPES



Multicomp Pro now offers a pair of tablet oscilloscopes, with bandwidths of 100MHz and offered in 2 or 4 channel variants.

Order Code  
**83AH9506**



## DIGITAL MULTIMETER WITH BLUETOOTH



The MP730624 from Multicomp Pro is a 4 1/2 bit resolution Bluetooth digital multimeter, with data logger and thermometer functionalities.

Order Code  
**93AH0320**



## BENCH DIGITAL MULTIMETER



The Multicomp Pro MP730028 is a 5.5 digit bench-type digital multimeter. Featuring a 4" LCD screen, reading rates of up to 150 readings, true RMS AC voltage and current measurements, dual line display support and multi-IO interface.

Order Code  
**10AH2407**



## BENCH POWER SUPPLY



The MP710257 from Multicomp Pro is a 300W, 60V/15A wide range programmable DC power supply.

Order Code  
**42AH2837**



## TABLETOP POWER SUPPLY



The TENMA 72-7660 Tabletop power supply is compact, regulated constant voltage power supply for service, hobby and telecommunications field equipment. Provides three different voltage outputs for different uses.

Order Code  
**22J0268**



## DIGITAL OSCILLOSCOPE



The MP720010 is a super economical 2-channel, 50MHz, 8bit digital oscilloscope. This oscilloscope features a 7" high-resolution color LCD screen, front USB IC design and ultra-thin device body.

Order Code  
**10AH2393**



## TEST LEAD SET



Test Lead Set with 3x black and 3x red test leads with various terminating connectors: 2x 4mm banana plug to hook clip, 2x 4mm banana plug to crocodile clips, 2x 4mm banana plug to 4mm banana plug.

Order Code  
**89AH1098**





**724 ESD TESTER, WORK STATION MONITOR, 15 %, 35 MM, 165 MM**



Single workstation continuous monitor with North America power adapter. Continuously monitors 2 operator dual-wire wrist straps and 1 work surface mat.



Order Code  
**83F8473**

**92-6115-US AIR FORCE BLOW-OFF GUN, 65PSI, 120VAC, HAND-HELD**



The 92-6115-US is an US-plug Ionizing Blow-off Gun with static-dissipative polyurethane enclosure, tungsten emitter points. This gun features ergonomic design, reduces fatigue and wrist hyperextension. Flexible, lightweight air hose with integral low voltage power cable moves with operator and does not interfere with work.



Order Code  
**83T4249**

**44523 TWEEZER, ESD, STRAIGHT, ROUND, STAINLESS STEEL, 125 MM OVERALL LENGTH**



Static Dissipative, Special alloyed, Non-Rusting, Stainless Steel. Coated by ESD-Safe Dissipative Material. Anti Magnetic and Acid resistant.



Order Code  
**28C1851**

**076722 TORQUE SCREWDRIVER, ADJUSTABLE, 1/4" F/HEX DRIVE, 7" LENGTH, 0.9N-M TO 9N-M, FGA SERIES**



076722 is a FGA-40 adjustable torque screwdriver. With the digital adjustable torque setting on the FGA, you can quickly switch torque values in the field or at the workstation, leading to improved productivity.



Order Code  
**49AK2125**

**50943 LOCKOUT DEVICE, CABLE, ALL PURPOSE, 8FT SHEATHED METAL CABLE**



The 50943 is a red all purpose Cable Lockout with 8-inch sheathed cable. The advantage of using cable lockout is it can be used in a wide variety of ways and can secure unusual energy isolating device that is difficult to lock out using conventional means.



Order Code  
**19K0026**

**09183 WRIST STRAP, ANTI-STATIC, ELASTIC, MAGSNAP, JEWEL SERIES**



Jewel® MagSnap adjustable wrist strap. Magnetic connection between wrist band and coil cord. Silver impregnated polypropylene knitted band material.



Order Code  
**20T7239**

**4006992-01 IONIZER, AIR GUN, TOP GUN SERIES, 120V, HANDS-FREE, 18" ADJUSTABLE GOOSENECK**



The Top Gun with Sidekick offers hands-free operation and flexible positioning during assembly and manufacturing processes. A foot pedal controls both ionization and airflow, which reduces compressed air costs and extends the life of the ionizer. The flexible gun mount allows the operator to focus the ionized airflow where it is needed.



Order Code  
**11J6671**

**2032-1 CONDUCTIVE BRUSH, TECHCLEAN, 1/2" X 3/8", HORSE HAIR**



The 2032-1 from Techspray is a high precision TechClean horse hair brush for cleaning and coating. This brush is used for cold/bucket cleaning, electronic assembly, electronic repair, electrical cleaning, office equipment maintenance and plant maintenance.



Order Code  
**80K6222**

**BP-100 TOOL BACKPACK, BALLISTIC NYLON, 20" x 14.5" x 8", 2.87 KG**



BP-100 is a Technician's tool bag backpack that features 36 organizer pockets and 12 pocket straps to hold all your tools in place with a durable water resistant base to protect it from the elements. It also has a hard, moulded front pocket for delicate items.



Order Code  
**93AJ2404**

**TR-600-HIK P APR KIT, VERSAFLO, HEAVY INDUSTRY, GAS/PARTICULATE/VAPOR, NIOSH**



TR-600-HIK heavy industry PAPR kit for rugged operations such as industrial, demolition, grinding, metal finishing and casting. The air purifying respirator takes the entire Versaflo system to new levels of confidence, control and comfort.



Order Code  
**57AJ1089**

**ASK-39793 MAT ROLL, DISSIPATIVE, VINYL, BLUE, 24" X 30', STATFREE B2 PLUS SERIES**



ASK-39793 is a dark blue STATFREE® B2 plus dissipative vinyl roll. Multi-layer vinyl Dissipative (1 x 106to <1 x 109 ohms Rtt) Top Layer. Conductive mesh inner layer. Conductive (<1 x 106Rtt) bottom layer.



Order Code  
**62AJ7876**

**91-XC2-US-05H IONIZER, BENCHTOP, EXTENDED COVERAGE, HEATED, 120 V, 14.13" X 7.2" X 6.5"**



Simco-Ion's new Aerostat XC2 provides complete wide area ionization protection. As with its' predecessor, the Aerostat XC2 Ionizing Blower, the Aerostat XC2 is designed and built for reliable, long-term static control for a variety of electronic, semiconductor, flat-panel display and medical assembly applications.



Order Code  
**72AC8590**

**5-1987 WIRE STRIPPER, ERGO-ELITE, 26-16 AWG CAPACITY WIRES**



The 55-1987 is a Wire Stripper with 16 to 26GA wire, ergonomically engineered for superior comfort, balance and control, tool constructed of rigid polyurethane reinforced with carbon fiber providing excellent strength at 40% the weight of metal hand tools.



Order Code  
**18K8801**

**26501-LED-8D MAGNIFIER, LED, 3X, MAGNIFICATION, 45" , ARM LENGTH**



The 26501-LED-8D is a ProVue 8-diopter LED Magnifying Lamp with 45-inch adjustable arm length. The ProVue LED 8D workbench lamp reduces eye strain and vision fatigue for high-volume industrial users.



Order Code  
**28Y7449**

**8511 PARTICULATE RESPIRATOR**



The 8511 Particulate Respirator features the proprietary 3M™ Cool Flow™ Valve and helps provide comfortable, reliable worker respiratory protection. It is ideally suited for hot/dusty work settings that require long periods of wear.



Order Code  
**31M7908**

**G3 BLUE SHOWER CLEANER/DEGREASER**



Non-flammable & powerful cleaner. Maintenance cleaners clean oil and contaminants off of metal parts, printed circuit boards, barcode instruments, switch boxes, gear boxes, and engines.



Order Code  
**81C8423**

**POW-R-WASH VZ CONTACT CLEANER**



Effective nonflammable solvent cleaner for electrical and electronic contacts and assemblies.



Order Code  
**97H7682**

**WXSMART ALL-IN-ONE SMART SOLDERING STATION**



All-in-one station designed to give you maximum connectivity, traceability, and process control.



Order Code  
**53AK8855**

**MX-5211 REWORK STATION**



Configured with the Advanced™ Handpiece. Highly effective for soldering applications.



Order Code  
**48W5012**

**10 PORT GIGABIT MANAGED ETHERNET SWITCH**



Gigabit Managed Ethernet Switches offer L2 features plus advanced L3 features such as Static Route for Enterprise networks via fiber or copper connections.



Order Code  
**06AC4115**

**SGB CONTACT TREATMENT GREASE**



SGB will significantly increase contact performance and lifetime.



Order Code  
**10WX6357**

**DOWSIL 3145 RTV MIL-A-46146 ADHESIVE SEALANT - CLEAR**



Clear, non-flowing adhesive with high tensile strength and elongation, MIL-A-46146 Group II tested.



Order Code  
**18K8092**

**LEADED NO-CLEAN WIRE SOLDER SN60PB40 (60/40) SPOOL**



Lead solder wire Alloy Sn60Pb40, Flux content 2.2%



Order Code  
**71AJ9518**

**951SX SOLDERING STATION**



The 951SX is a LONER® 120V 220W temperature controlled Soldering Station which features an industry standard, highly dependable and cost efficient soldering station.



Order Code  
**92F8585**

**BLACK BOX LMC280 SERIES LMC280A FIBER MEDIA CONVERTER**



Converter provides a way to add fiber to your existing network infrastructure. It converts 10/100Base-T(X) to 100BaseFX. Supports MDI/MDIX auto detection to avoid use of x-over cables.



Order Code  
**33AH5883**

**DEOXIT D5 SPRAY**



Unique contact cleaner, rejuvenator, conductivity enhancer and lubricant. Dissolves oxidation and corrosion on metal surfaces.



Order Code  
**42J5218**

**IS800 SERIES ONE-COMPONENT, READY-TO-USE SILICONE ADHESIVE SEALANTS**



Paste-like consistency and cure to silicone rubber on exposure to atmospheric moisture at room temperature.



Order Code  
**00Z1579**

**HCT-910 HOT AIR REWORK SYSTEM**



Hot air rework system offers a versatile solution for a wide variety of production and rework applications.



Order Code  
**42AK3688**

**WELLER WE1010NA SOLDERING STATION**



WE1010NA works best for professional soldering jobs, PCBs, electronic kits, low-voltage wiring, and cable assembling.



Order Code  
**45AC9886**

**ULTIMAKER S7 3D PRINTER**



UltiMaker S7 is your gateway to the entire UltiMaker platform. Access all the tools you need to start 3D printing – manage and monitor your prints securely with the UltiMaker Digital Factory, access e-learning courses on the UltiMaker Academy, and more.



Order Code  
**68AK0804**

**NEW MULTICOMP PRO STUB END STRIPPER FOR RG6 AND RG59 COAX CABLES**

The Multicomp Pro MP010404 is a tool for stripping and prepping coaxial cable in the tightest places, such as MDU boxes, wall plates and most tight places.



Order Code  
**46AK9128**

**NEW MULTICOMP PRO CRIMP TOOL FOR RJ11 & RJ45 CAT5, CAT5E, CAT6 UTP MODULAR CONNECTORS**

The Multicomp Pro MP010403 is a Dual Chamber Modular connector crimping, stripping, and cutting tool, for RJ11 and RJ45 CAT5, CAT5e, and CAT6 UTP (Unshielded Twisted Pair) modular connectors.



Order Code  
**46AK9127**

**METAL FOLDING HEX AND TAMPER STAR KEY SETS**

CRV+Chamfer Material with Metal Cover. 7 Pieces 1.5/2/2.5/3/4/5/6mm Metal Folding Hex Key Wrenches



Order Code  
**29AK2347**

**TECHNICAL CLEANING BRUSHES**

Multicomp Pro now offers a range of technical cleaning brushes with horse hair bristles.



Order Code  
**77AJ8511**

**32 PC, SCREWDRIVER SET**

The MP700128 is a 32-piece magnetic screwdriver set. The bit block has all the options that user need for fastening specialty screws found in electrical boxes, conduit couplers, outlets and other common job site fixtures.



Order Code  
**34AH5387**

**HELPING HANDS WITH MAGNIFIER**

Clips and magnifier can be adjusted in any direction. Removable, metal sponge tray Robust steel base, Suitable for soldering, PCB and circuit board repairs Lens diameter: 90mm Magnification: 3x



Order Code  
**36AJ3913**

**STORAGE CASE**

The Multicomp Pro 17028.207.SPU Storage Case features innovative design with soft lines, its stackable, moulded polypropylene and includes Foams.



Order Code  
**99Y9786**

**ELECTRONICS CUTTER KIT**

This set consists of 4 Pliers: MP700389 Micro Cutting Electronics Cutter - Conductive Handle; MP700390 Heavy Duty Micro Cutting Plier - Dissipative Handle; MP700391 Heavy Duty Micro Cutting Plier with Safety Clip & Dissipative Handle; MP700392 Micro Cutting Plier - Dissipative Handle



Order Code  
**37AJ4433**

**TACTICAL WATERPROOF EQUIPMENT CASE**

These waterproof cases are high quality and specification can be relied on for military use, travel, offshore, etc. They are perfect for protecting items in extreme environments and are ideal for transport and protection of camera and audiovisual equipment, electronics, etc.



Order Code  
**83X6730**

**WELDING FUME EXTRACTOR**

The MP740146 ESD safe benchtop fume extractor can be operated vertically or horizontally, it can quickly, safely and quickly remove soldering fumes and smoke. The filter is made of highly activated carbon, strong and absorbent.



Order Code  
**39AH0171**

**SOLDER POT**

The MP740404 is a corrosion-resistant and heat-resistant alloy solder pot, that is suitable for lead-free operation. This solder pot with temperature control from 200 C to 480 C has a beautiful design is reliable and practical.



Order Code  
**26AJ4698**

**SOLDER SMOKE ABSORBER**

The MP740766 Solder Smoke Absorber can be used as a bench fan or as a solder smoke absorber. The fan is designed to sit on a desktop or can be hung from a support beam. 1 carbon fibre filter is included with low noise and long life service fan.



Order Code  
**26AJ4723**

**RATCHET CRIMP TOOL KIT**

The MP009830 Tool Kit is a versatile solution for all your crimping needs. This comprehensive Ratchet Crimp Tool Kit comes equipped with a range of five interchangeable dies, ensuring that you have the perfect tool for every crimping task.



Order Code  
**33AK6818**

**WIRE STRIPPER**

The Multicomp Pro MP009732 is a Wire Stripper with Self-Adjusting Insulation, 24AWG to 10AWG Capacity.



Order Code  
**32AK6333**

**ABS 19" RACKMOUNT FLIGHT CASES**

Made with durable ABS, Aluminum, Steel, Industrial quality butterfly clips, Gasket sealed lids for maximum protection against dust, moisture, and other unwanted contaminants.



Order Code  
**25AC5169**



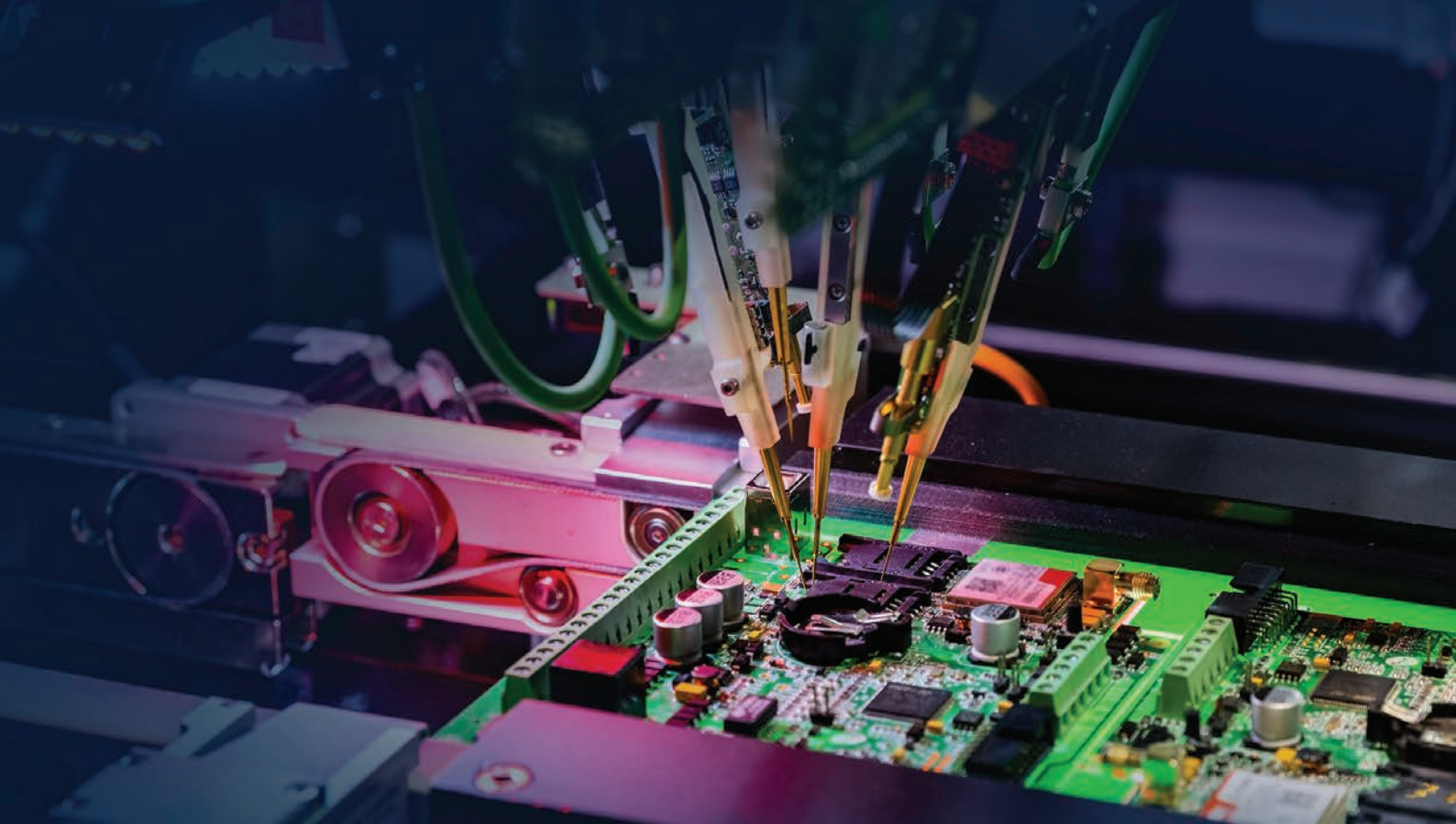

# INDUSTRIAL EMBEDDED COMPUTERS

## Enabling Next Generation of Industrial Applications

We offer the latest cutting-edge industrial embedded computers designed for use in today's most demanding industrial IoT and edge computing environments.

To give you peace of mind, our industrial computers help reduce downtime and prevent failures. Embedded computers from industry-leading suppliers are available in a variety of form factors that are ideal for space-constrained implementations and are engineered for performance and reliability.



Rugged for harsh environments



Multiple connectivity



Compact form factors



Compliance and support



Long time availability



Extended I/Os

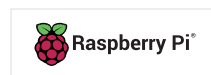

**RASPBERRY PI COMPUTE MODULE 4 IO BOARD**



The Raspberry Pi Compute Module 4 IO Board (CM4IO) is designed to assist in the development of products that make use of the Raspberry Pi Compute Module 4.

Order Code  
**86AH2064**

**RASPBERRY PI COMPUTE MODULE 4, 8GB RAM, 32GB EMMC, WITH WIFI AND BLUETOOTH**



Raspberry Pi Compute Module 4 harnesses the compute power of the popular Raspberry Pi 4 Model B, bringing it to a smaller form factor suitable for integration into products.

Order Code  
**92AH8122**

**SBC, ARDUINO PORTENTA C33**



The ABX00074 is a Portenta C33 board that is a powerful System-on-Module designed for low-cost IoT applications. Based on the R7FA6M5BH2CBG microcontroller from Renesas®, this board shares the same form factor as the Portenta H7 and it is backward compatible with its connectors.

Order Code  
**77AK2285**

**ARDUINO MICROCONTROLLER BOARD**



Seeeduno XIAO is the smallest Arduino compatible board in Seeeduno family. It is an Arduino microcontroller that is embedded with the SAMD21 microchip.

Order Code  
**29AK9834**

**ARDUINO ABX00042, SBC**



Portenta H7 module simultaneously runs high level code along with real time tasks. Its two asymmetric cores can simultaneously run high level code such as protocol stacks, machine learning or even interpreted languages like MicroPython or Javascript along with low-level real time tasks.

Order Code  
**67AH8877**

**MBT0021-EN, ADVANCED STEM EDUCATION ROBOT**



MBT0021-EN is a latest version of Maqueen Plus. It is a programming robot that is optimized with more expansion ports, larger capacity power supply and larger body.

Order Code  
**87AH6189**

**ABX00080, SBC, ARDUINO UNO REV4 MINIMA**



ABX00080 is an Arduino® UNO R4 Minima board. The Arduino UNO R4 Minima (from here on referred to as UNO R4 Minima) is the first UNO board to feature a 32-bit microcontroller.

Order Code  
**77AK2286**

**MBT0021-EN-18650, ROBOTIC KIT**



MBT0021-EN-18650 is optimized with more expansion ports, larger capacity power supply, and larger body. It is fully compatible with more peripheral components like HuskyLens AI camera and Maqueen Mechanic Kits.

Order Code  
**33AK3292**

**LATTEPANDA 2 ALPHA 864S, 8GB/64GB, WIN10 PRO**



LattePanda 2 Alpha 864s (Win10 Pro activated) is a high-performance, pocket-sized SBC (single board computer) with low power consumption that runs full Windows 10 or Linux operation system.

Order Code  
**87AH5899**

**LATTEPANDA 3 DELTA BOARD, 8GB/64GB, WIN 10**



LattePanda 3 Delta 864 – The Fastest Pocket-sized Windows/Linux Single Board Computer with Win10 Enterprise License (8GB/64GB).

Order Code  
**31AK8094**

**NVIDIA JETSON NANO MODULE, 4GB/16GB**



The NVIDIA® Jetson Nano™ module is opening amazing new possibilities for edge computing. It delivers up to 472 GFLOPS of accelerated computing, can run many modern neural networks in parallel.

Order Code  
**62AK4312**

**NVIDIA JETSON XAVIER NXMODULE, 8GB/16GB**



With 8GB RAM and 16GB EMMC the NVIDIA® Jetson Xavier™ NX brings supercomputer performance to the edge in a compact system-on-module (SoM) that's smaller than a credit card.

Order Code  
**62AK4313**

**NVIDIA JETSON XAVIER NX MODULE, 16GB/16GB**



With 16GB RAM and 16GB EMMC the NVIDIA® Jetson Xavier™ NX brings supercomputer performance to the edge in a compact system-on-module (SoM) that's smaller than a credit card.

Order Code  
**62AK4314**

**NVIDIA JETSON XAVIER DEVELOPER KIT, 8GB/16GB**



With 8GB RAM and 16GB EMMC the reComputer J20-series are compact edge computers built with NVIDIA advanced AI embedded systems: Jetson Xavier NX and Seeed reference carrier board (J202).

Order Code  
**62AK1978**

**ABX00051, DEVELOPMENT BOARD**



Arduino® Nicla Vision packs machine vision capabilities on the edge into a tiny fingerprint. Record, analyse and upload to the cloud all with the help of one Arduino® Nicla Vision.

Order Code  
**31AK5790**

**M610 BLUETOOTH LABEL PRINTER CONTRACTOR KIT**



M610-B-PWID is a M610 Bluetooth handheld label maker with workstation product & wire ID software and hard case. It's enhanced capabilities include bluetooth connectivity, military grade shock resistance, below freezing operating temps and the widest range of data entry options.



Order Code  
**74AK9281**

**SHIPBOARD AV**



The 8723SB 0101000 is a 1000ft 2-pair 4-conductor audio control interconnect Shipboard Cable with 22AWG stranded (7 x 30) tinned copper conductors, polypropylene insulation, 100% Beldfoil® aluminum foil-polyester tape shield (100% coverage) and black low smoke zero halogen (LSZH) jacket.



Order Code  
**1179042**

**OLFLEX TRAY II CY**



Ölflex® Tray II CY is an Industrial Grade Shielded Multiconductor Tray Cable with superior oil performance for long cable life. It has a pressure-extruded jacket and fine copper stranding for excellent flexibility. With UL TC-ER approval, no conduit is needed reducing material costs and saving on labor.



Order Code  
**69AC7456**

**GROMMET**



The QFG-16220 is a Grommet. Features: Open, 6 mm, TPE (Thermoplastic Elastomer), 10 mm, 3 mm



Order Code  
**28AH1246**

**PAN STEEL CABLE TIE**



MLT series Pan-Steel® self-locking cable tie speeds up installation with a unique self-locking head design that locks into place at any part of the tie body. Provides additional edge protection and prevents corrosion between dissimilar metals.



Order Code  
**84F1854**

**MULTICORE CABLE OR TV CAMERAS AND CCTV**



The features of the Multicore cable include 13 conductor (1 coax, 12 cond), remote control and video cable, foam polyethylene (coax) and PVC (cond) insulation, coax: BC braid (95% coverage), overall TC braid (80% coverage), overall PVC jacket.



Order Code  
**04F8951**

**ENVIROFLEX RG316**



RG316D/RD316 LSFH, 50 Ohm, 6 GHz, 105°C, ø3.16 mm, RADOX® jacket, Flame retardant, UL AWM style 3651, CPR qualified



Order Code  
**89AH1615**

**FIT221 HEAT SHRINK TUBING**



The FIT-221-1/2 WH105 is a 20ft white multipurpose irradiated polyolefin Heat Shrink Tube ideal for harnessing, wire bundling, strain reliefs or any applications where components must be insulated or packaged. FIT® 221 flame-retardant tubing has a shrink ratio approximately 2:1 at 121°C.



Order Code  
**97F8956**

**CLT SLEEVING**



Corrugated loom tube protects cables from impact and abrasion. Slit for easy installation onto a bundle of wires or a pre-assembled harness assembly. UL94-HB flammability rating and a maximum temperature rating of 122°F (50°C)



Order Code  
**96F4123**

**2922NH CABLE GLAND**



The 2922NM is a 1/2-inch straight liquid-tight Cord Connector made of nylon. The Ranger™ series non-metallic provides extended range with superior strain relief. Reduced overall size, fits into tighter space. Gland nut designed to restrict cable bending.



Order Code  
**48F2928**

**DATATUFF PROFINET CAT5E CABLE**



22 AWG Symmetric quad solid bare copper conductors, polyolefin insulation, FRPE bedding, industrial grade sunlight- and oil-resistant PVC jacket, rip cord. Sequential marking at two foot intervals. PROFINET Type A cable.



Order Code  
**77Y6060**

**SKINTOP MSR CABLE GLAND**



The 53112016 Skintop® MSR-NPT Reducer Bushing Strain Relief Cable Gland from Lapp is a superior quality, liquid-tight, metallic cable gland intended for applications where ruggedness and durability are required.



Order Code  
**61AC3753**

**SLEEVING, OVAL WIRE**



The 2144 SV005 is a Braid Tinned Copper Oval Sleeve. The sleeving is an exceptional, low resistance way to create a point-to-point ground strap. In retrofit applications, braid is an ideal way to install additional shielding to your cable.



Order Code  
**02F9795**

**NYLON 6.12 CABLE TIE**



Cable Tie, 188MM, Nylon 6/12, 50LB ROHS Compliant: YES



Order Code  
**68AK6020**

**ERG50 CABLE MANAGEMENT TOOL**



The ERG50 tool from Thomas & Betts is a cable tie installation tools. This tool is used for cable tie tensile strength from 80N to 220N. The ERG50 provide a superior level of reliability and performance combined with enhanced ergonomics and comfort of use.



Order Code  
**22M0151**



**TRIM TRIO® WATERPROOF CONNECTORS**



The UTG61412PN from Souriau is a plastic circular cable plug connector housing with 12 pin contacts. This connector has shell size of 14. UTG series connectors are economical, lightweight and have robust metal locking system.



Order Code  
**16F5735**

**M12 SENSOR CONNECTORS**



Connector System for machine industrial automation and control applications provides a solution for the increasing needs of sensor connections that safely and reliably ensures the communication in industrial environments.



Order Code  
**97Y2334**

**M12 PUSH-PULL CONNECTORS**



The SACC-M12MS-8CON-PG9-M is a 8-position straight M12 Plug-in Connector with Au plated CuZn contact, PA carrier contact and grip body, zinc die-cast/nickel-plated knurls and NBR sealing. Flexible connectors for on-site assembly.



Order Code  
**70W0559**

**HD SERIES HEAVY DUTY CONTACT**



HD Series of Heavy duty connector, copper alloy crimp; gas-tight and corrosion-resistant.



Order Code  
**10B7656**

**AT SERIES CRIMP**



Amphenol AT Series stamped & formed contacts designed for heavy duty applications to accommodate 4AWG wire size, nickel plated.



Order Code  
**71AH0481**

**900 SERIES BUCCANEER**



The PXA911/07/P from Bulgin is a Buccaneer 7 Pole flex cable connector plug.



Order Code  
**14J6734**

**APD SERIES CONNECTORS**



The APD-1BS-K2 is a 4-way high-power plug with silver-plated copper-alloy contacts. This APD series plug has a PBT housing and a PA 66 coupling nut.



Order Code  
**65T3409**

**NANO-CHANGE SERIES CONNECTORS**



The N03MA03124 is a 3-pole straight male Field Attachable Connector with gold-plated brass contacts. The Nano-Change® (M8) industry standard connector is rugged, space-saving and sealed connector for miniature sensors and actuators in industrial control applications.



Order Code  
**12N2328**

**CGRID III HEADER**



CGrid III 40 contact through hole pin header, versatile design breakaway header, gold plated contacts.



Order Code  
**60H4193**

**HAN E SERIES CONTACTS**



Han E Series heavy duty contacts feature copper alloy, gold plated contacts for 10AWG wire ideal for industrial design.



Order Code  
**49AK6843**

**CPC SERIES 1**



Rugged, cost-effective connectors that can be used to provide power input and output to and from virtually any device. The use of CPC cable assemblies enables customers to reduce installation time, meet harsh and space saving requirements.



Order Code  
**46F313**

**CAPLOCK & PLUGLOCK LOCKING ACCESSORIES FOR 38999, RJFTV, USBFTV CONNECTORS AND CAPS**



CapLock is a locking ring that allows a Cap to lock onto a receptacle to secure the port access. PlugLock is a locking ring that allows a plug to lock onto a receptacle to secure the plug to receptacle connection.



Order Code  
**41AK2416**

**DUALOBE SERIES RECTANGULAR POWER CONNECTOR**



Dualobe Series PCB Mount Rectangular Power connector, 15 contacts, Surface Mount, with termination screws.



Order Code  
**08H4189**

**MICROFIT HEADER, BLIND MATE**



MicroFit 3.0 Family is rated up to 5.0A at a small-form 3.00mm pitch. Dual row header features guides for blind mating, heavy duty applications.



Order Code  
**01AH1254**

**MEGA-FIT OVERMOLDED CABLE ASSEMBLY**



Molex Mega-Fit Overmolded Cable assembly, 2 position receptacle 19.7" length wire; many options available.



Order Code  
**88AH3256**

## HAN MODULAR COMPACT



Han Modular series of heavy duty connector hood features side cable entry mounting, die-cast zinc with nickel plated finish and is for use in -40°C to +125°C temperature range



Order Code  
**29H1466**

## MAGNETIC 5A CONNECTORS



The MP magnetic connectors are a fantastic solution if you require a 2 contact connector, Nd-Fe-B magnetic connectors able to withstand at least 5000 mating cycles. Cable connector available as in-line or right angle and comes with 2m 2 core cable.



Order Code  
**64AH1568**

## MINI I/O CONNECTORS



Rectangular connectors that transfer data between devices in industrial applications. Supporting Power over Ethernet (PoE), PoE+ and PoE++ (IEEE802.3at and IEEE802.3bt) and Data rates from 10Mbps up to 10Gbps.



Order Code  
**40Y2963**

## IP67 RJ45 / USB CONNECTORS



For data communication in harsh environments. CONEC has developed USB and RJ45 connectors in plastic, metalized plastic or full metal shells with IP67 protection IP67 for use where dust and spray water occur.



Order Code  
**61AK4816**

## MICRO D CABLE ASSEMBLIES



High density miniaturized connectors supporting the demand for environmentally safe, high temperature and ruggedized moisture-sealed interconnects.



Order Code  
**75AH8605**

## INDUSTRIAL ELECTRICAL CONNECTORS



A comprehensive range of CEE Connectors available in IP44 & IP67 variants. Ruggedized Male & female options in 3, 4, & 5 poles. Complies to CEE/IEC 60309-1/60309-2. Suited to many applications including, Industrial, Factory & Warehousing, Machinery, Workshops plus many more.



Order Code  
**67AK5680**

## IP67 MP-Y13 / MP-Y21 BAYONET POWER CONNECTORS



A robust range of connectors incorporating bayonet couplings for quick and easy connection/disconnection. Panel mount, cable mount and in-line cable mount options allow versatility. The MP-Y13 series offers up to 13A / 250V and MP-Y21 series up to 30A / 500V.



Order Code  
**64AH1645**

## BRAD INDUSTRIAL ETHERNET CONNECTORS



Bayonet Style and threaded RJ-45 connectors designed to Ethernet specifications. Provides reliable connectivity in harsh industrial automation environments.



Order Code  
**02AC9677**

## MACHINED MICRO-D SPACE SAVING CONNECTOR TECHNOLOGY



Machined Micro-Miniature Interconnect for Cables, Boards and Panels Hand Held & Portable Devices, Wireless Base Stations, Military Telematics, DC/DC Power Supplies, Test & Measurement, Industrial Robotics.



Order Code  
**31AJ9720**

## M24308 CONNECTORS



Small enough to fit into tight spaces and with proven reliability, MIL-DTL-24308 connectors are an ideal choice for mission-critical tasks where connector performance cannot be a question. Positronic has held its position on the MIL-DTL-24308 QPL for over 40 years.

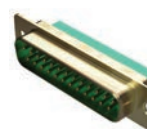

Order Code  
**41AJ7431**

## HEAVY DUTY CONNECTORS



A full range of heavy-duty inserts, housings, crimps and accessories. These connectors have been created for applications that are subjected to harsh environments or where high vibration can cause standard connectors to fail. Ideal for food & beverage manufacturing, packaging machines, conveyor belt systems, railway, oil & gas.



Order Code  
**32AK0456**

## IP67 M12 PUSH-PULL CONNECTORS



The MP M12 push-pull connectors are a range of chrome plated brass connectors that are both solid enough to be used within tough environments whilst also being aesthetically pleasing. 12mm panel cutout size, push-pull coupling, 2-9 poles, rated up to 13A / 250V, minimum of 500 mating cycles.



Order Code  
**64AH1717**

## IX INDUSTRIAL® ETHERNET INTERFACE



Miniaturized alternative to the RJ45 for IIoT and industry 4.0. Smaller and more robust IP20 plug-in connection which can still produce Cat 6A performance for 1/10Gbit/s Ethernet.



Order Code  
**78AC4930**

## SINGLE PAIR ETHERNET IP20 CONNECTORS



Single Pair Ethernet (SPE) connectors for Industrial applications bring direct Ethernet connectivity to peripheral devices like sensors, actuators, and vision system cameras that operate at speeds up to 1Gb/s.



Order Code  
**62AJ3553**

## USB TYPE C 240 W POWER DELIVERY



Avoid the frustration of product to failure with GCT's range of high reliability USB Type-C connectors rated at 20,000\* cycles which is twice the industry standard.



Order Code  
**86AH2022**

# / A WORLDWIDE TEAM WITH A LOCAL FOCUS



## Headquarters & Offices in NA

|                         |                                    |                                    |
|-------------------------|------------------------------------|------------------------------------|
| <b>US</b><br>newark.com | <b>Mexico</b><br>mexico.newark.com | <b>Canada</b><br>canada.newark.com |
|-------------------------|------------------------------------|------------------------------------|





**Newark**

AN AVNET COMPANY

# BUILD AND MAINTAIN YOUR INDUSTRIAL CONTROL PANEL FOR 20% LESS\*

From the enclosure outside, the components within, and everything else that keeps them operating safely – engineers choose Multicomp Pro.

Developed by our engineers for engineers like you, Multicomp Pro products and components meet the quality standards engineers require and the value they need to build and maintain industrial control panels at a lower cost without sacrificing quality.

- > Cable & Cable Management
- > Tools
- > Outside the Panel
- > Inside the Panel
- > Panels
- > Converters

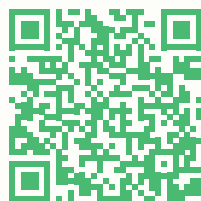

\*Typically 20% less than other brands

**multicomp** PRO